



PARA BIATHLON RANGE AND EQUIPMENT CERTIFICATION MANUAL

PARA NORDIC

OCTOBER 2022



Table of Contents

| | | |
|----------|--|-----------|
| 1 | Preamble | 4 |
| 2 | Background | 4 |
| 3 | Application | 5 |
| 4 | Range and Equipment Certification Protocol | 5 |
| 4.1 | Range Equipment Certification..... | 5 |
| 4.2 | Physical Range Certification..... | 6 |
| 4.3 | Control..... | 6 |
| 5 | Approval of Para Biathlon Shooting and Target Systems | 7 |
| 6 | Specifications Para Biathlon Air Rifle, Targets and Equipment | 7 |
| 6.1 | Air-rifle Target Operating Systems Description | 8 |
| 6.1.1 | Metal Air Rifle Target Specifications | 8 |
| 6.2 | Approved Air Rifle Targets | 9 |
| 6.3 | Rifle Support Specifications..... | 9 |
| 7 | Specifications for Shooting System for Vision Impaired Athletes | 10 |
| 7.1 | EcoAims E-BSS2006 | 10 |
| 7.2 | Updates, settings, and additional specifications:..... | 12 |
| 7.2.1 | Rifle Software | 12 |
| 7.2.2 | Display Unit..... | 13 |
| 7.2.3 | Targets..... | 13 |
| 7.2.4 | Infrared light emitting target diodes..... | 13 |
| 7.2.5 | Headphone Calibration | 13 |
| 7.2.6 | Additional components..... | 14 |
| 7.3 | Special Requirements for Electronic Scoring Systems..... | 14 |
| 8 | Range and Penalty Loop Layout Specifications | 15 |
| 8.1 | General Requirements | 15 |
| 8.2 | Para Biathlon Range Layout..... | 16 |
| 8.2.1 | Specifications for range layout and target setup are illustrated and can be found in Annex 1. | 16 |



| | | |
|---|-----------------------------|---|
| 8.3 | Penalty Loop Layout..... | 17 |
| 9 | Administration | 19 |
| 9.1 | Contacts | 19 |
| Annex 1: Range and Penalty Loop Specifications and Drawing | | Fehler! Textmarke nicht definiert. |
| Annex 2: Range and Equipment Checklist..... | | 20 |
| Annex 3: Equipment Registry Template..... | | 25 |



1 Preamble

Sanctioned Para Biathlon (PBT) competitions are organized according to the Para Nordic International Competition Rules (ICR). These competitions must take place using range facilities and equipment that conform to the rules.

This manual outlines the following:

- Para Biathlon range and penalty loop requirements
- Para Biathlon equipment specifications
- Range and equipment certification requirements and procedures

2 Background

Para Biathlon was introduced into the Paralympic Winter Games in Innsbruck in 1988 for athletes with a physical impairment. In 1992, athletes with vision impairment also became eligible to compete with the development of a blind shooting system.

Para Biathlon range equipment and target systems have developed and evolved over the years. The current target systems were developed in the 1990's and have been in use ever since with various updates, upgrades, and additions over the years. The current blind shooting system for vision impaired athletes was originally developed for the Finnish military training as an alternative to using live ammunition. It was further developed for Para Biathlon sport and first used at the 2002 Paralympic Games.

During the developmental stages of the sport, there was one set of biathlon equipment including a set of air rifles¹, mechanical air targets and a set of blind shooting systems that was previously owned by World Para Nordic Skiing (now IBU) that was used for all World Cup and World Ski Championship competitions and shipped from event to event (primarily in Europe). At Paralympic Winter Games, range equipment is supplied directly by Kurvinen/EkoAims².

Over the past decade, as the sport has continued to develop, different shooting systems have been considered and the exclusive use of IBU owned range equipment has become supplemented by locally or regionally owned range equipment. There are now several sets of equipment in use for Para Biathlon competitions and for training. This equipment acquired over time and occasionally for different purposes (training versus competition) includes a variety of components of different ages, models and features and in some cases is even dispersed amongst different users for training purposes.

Most Para Biathlon ranges used for training and/or competition are temporary setups rather than permanent installations. They are set up at venues that have permanent 10m air rifle and/or 50m (IBU) ranges and adapted for PBT use, or at venues (including cross-country

¹ The previously provided air rifles were eventually replaced by privately owned air rifles.

² Current approved supplier of Para Biathlon air rifle target, blind shooting system and electronic scoring systems.



skiing venues) where no permanent biathlon infrastructure exists. In these cases, temporary ranges and penalty loops must be installed.

The purpose of range and equipment certification is to ensure that Para Biathlon ranges and equipment used in the Para Nordic competitions meet current standards and requirements.

3 Application

- ❖ These technical requirements apply to all sanctioned Para Nordic competitions.
- ❖ These requirements apply to range adaptations at permanent biathlon venues as well as temporary range installations at non-biathlon venues.
- ❖ Biathlon range equipment (shooting, target systems and related components) must be maintained according to the most recent standard as updated from time to time and published in this document.
- ❖ Para Biathlon equipment used in FIS sanctioned Para Biathlon competitions must be certified according to this Manual a minimum of 3 months prior to an event. The status of range equipment certification will be considered during the sanctioning process.
- ❖ Biathlon range layout and related infrastructure must be certified during test events held prior to World Championships and Paralympic Winter Games.

Technical range and equipment requirements and related certification procedures are contained in this manual.

This manual is supplementary to the ICR which provide the foundation for Para Nordic competitions. Related guidelines that apply also include:

Operational procedures for setup, control, scoring and results production which are found in the Para Biathlon Operational Guidelines.

Stadium and competition course requirements and related homologation procedures which are found in the Para Nordic Cross Country Homologation Manual and Competition Formats document.

4 Range and Equipment Certification Protocol

4.1 Range Equipment Certification

All sanctioned Para Nordic competitions shall be carried out using certified range equipment.

To be considered for certification range equipment must first be entered into the Range equipment registry (Annex 3). Once entered the equipment details will be reviewed by FIS. Equipment components and related equipment must be maintained to current published standards. Verification of current status will be conducted as follows:

- ❖ Through direct contact and liaison (interview) with designated range owner / contact person to ensure completeness of registry information.



- ❖ Cross-reference of equipment version / edition information with Kurvinen/EcoAims to verify component status and what updates / upgrades have been completed.
- ❖ If required, or requested by a venue/range equipment holder, a site inspection visit by a qualified Para Biathlon IR to physically inspect and verify status of the biathlon equipment.
- ❖ The costs of equipment upgrade and maintenance to maintain certification are the responsibility of the equipment owner.
- ❖ The costs of physical inspection visits (if required) are the responsibility of the equipment owner.
- ❖ Range equipment certification is valid for two years (competition seasons) before it must be reviewed by FIS for renewal. The range owner is responsible for updating and maintaining their registry information on an ongoing basis whenever any new equipment is acquired or when any changes or upgrades are implemented.

Only factory authorized or installed/repaired alterations are permitted, and may be implemented by the equipment manufacturer, PBT IRs or authorised representatives of the venue/equipment owner. Proof of authorization by the equipment manufacturer will need to be provided as part of the certification process.

4.2 Physical Range Certification

Para Biathlon ranges used for World Ski Championships and Paralympic Winter Games will also require FIS certification. This includes physical layout and related infrastructure (firing line, number of lanes and lane width, target platforms/ supports, target backwall, cabling, results hut, scoring infrastructure, coaches, media and VIP boxes, zeroing loop, penalty loop, safety zones, TV and media camera positions, spectator viewing, range access etc.) The range certification checklist will be used as a basis for this inspection that will take place during test events and/or the final inspection prior to the event and confirmed upon arrival on site.

Ranges used at world cup and below are expected to be consistent with these requirements however at these competitions it is the responsibility of the assigned Biathlon International Referee, upon arrival, to inspect and ensure that the physical range layout and setup is consistent with these requirements.

4.3 Control

FIS will not sanction a Para Biathlon competition without there being a certified range in place. Potential organizers must therefore submit details regarding biathlon range plans together with their sanctioning application.

In the event that FIS discovers that range equipment at a sanctioned competition site does not conform to the latest requirements, FIS may pull sanctioning for related para-biathlon events



meaning that no points would be awarded. A decision related to eligibility for points will be made at the discretion of the assigned technical delegate and biathlon international referee.

5 Approval of Para Biathlon Shooting and Target Systems

Shooting and Target systems used at FIS competitions must be approved by the Sub Committee Para Nordic.

Potential suppliers may submit new shooting systems or equipment (Art 12332.3) that meets the ICR and requirements for evaluation, testing and approval by the sport at a Sports Forum before new systems will be considered for implementation.

Approval may be withdrawn for existing equipment or one of their components if persistent technical errors occur or if specific components or entire systems become technically outdated.

Authorized systems are listed in art. 12332.3 of the ICR.

Currently, the following biathlon systems are approved for use in sanctioned Para Nordic competitions:

- Kurvinen Air Rifle Mechanical Target System, FIN
- Kurvinen Air Rifle Electro-Mechanical Target and KES 2002 Controller / Scoring System, FIN
- EcoAims Biathlon Shooting System for Vision Impaired Athletes, FIN

Further descriptions and specifications of approved equipment are included in subsequent sections of this manual.

6 Specifications Para Biathlon Air Rifle, Targets and Equipment

The rules for Para Biathlon shooting systems are described art. 12332.3 of the ICR. LW (air rifle) target requirements are described in art. 12332.1.11 through 12332.1.16.

The LW (air rifle) shooting range includes the following components including three different types of targets:

- Mechanical manual reset targets
- Electromechanical reset targets
- Automated scoring system targets (and related cabling and electronic processing units)
- Short (fixed) target legs
- Long (adjustable) target legs
- LW shooting board with shooting support bases



- LW shooting support

6.1 Air-rifle Target Operating Systems Description

Air rifle targets are produced in mechanical and electro-mechanical variations. They operate as follows:

1. Mechanical Target Operating Systems

Mechanical targets indicate the hit of a bullet by the physical force of the bullet impact knocking down the target and replacing it with a white indicator disc. Mechanical targets are manually reset after a round of shooting by pulling a reset string to bring the fallen target plates back into position. The reset string runs from the rest loop on the right side of the target to the lane marker post on the right side of the lane. The reset strings and wind flags for manually operated targets must not interfere with operation of the target or shooting. An external red bar indicates when a target has not been reset.

2. Electro-Mechanical Operating Systems

This is a mechanical target with an electronic reset system. A hit is indicated by the physical force of the bullet impact knocking down the target and replacing it with a white indicator disc. Targets are reset by electrically powered servomotors installed on the back of the target. Reset can occur automatically after a set time interval or by remote control using a lane/target controller. (also used for manual scoring entry)

3. Electronic Scoring Systems

With electronic scoring systems, hits are recorded electronically through a motion/impact sensor in the target. Hits are visually indicated by the physical force of the bullet impact knocking down the target and replacing it with a white indicator disc. Targets are reset automatically or by remote control using a lane/target controller. Scoring data is processed automatically and transmitted directly to the timing system and TV graphics.

6.1.1 Metal Air Rifle Target Specifications

Targets must consist of a white target face plate with 5 target apertures, behind which there must be 5 independently operating knock-down, falling-plates. The scoring plates must be black. A hit must be indicated by the black target circle being replaced by a white indicator disc.

Functional Requirements for Metal Air Rifle Targets

The target system must meet the following requirements:

- Reliable functioning under all types of weather conditions in which competitions are held;
- Hits must be shown at a standard hit impact momentum (releasing impact) that has been determined by the Sub Committee Para Nordic, to ensure that the



releasing impact momentum is the same for all targets used during a competition.

- Must have a red 'not reset' indicator – such that when the indicator is in the up position it indicates that the target is not reset.

Tolerances and Shape Requirements

The size of target openings must be:

- Diameter of open hole 13 mm, +/- 0.2 mm;
- Diameter of black aiming ring 35mm +/- 0,2mm;

Materials and Hardness

- Metal targets must be made of steel with a Brinell Hardness (HB) of at least 150 – 190 HB.
- The 6mm bolt for fixing the paddle to the target must be 200HB.

Release Impulse

- A target should show a hit when hit by a bisected pellet at a release impulse of at least 50% of bullet impulse. (minimum release impulse to be quantified and specified in the future)

Zeroing frame

- Detachable zeroing frames attach to the right side of the target and support zeroing paper & back boards during zeroing.

6.2 Approved Air Rifle Targets

Currently, the following target models, manufactured by Kurvinen Biathlon Systems are approved for use in Para Biathlon competitions. Manually reset or electro-mechanically reset targets may be used at World Championships, World Cup and lower levels of sanctioned Para Biathlon competition. At Paralympic Winter Games electro-mechanical targets with automated scoring system are required.

Model Number:

- B00697A (manual reset)
- B00500A (automatic reset, no scoring)
- B00673A (automatic scoring and reset)

6.3 Rifle Support Specifications

Rifle supports are adaptive equipment used by athletes with upper limb impairments when they are unable to hold and aim the rifle with a support arm. These consist of a 'T' support with

a vertical post comprised of a solid base and vertical spring shaft covered with a flat, horizontal top plate with a non-slip surface where the rifle rests. The support is inserted into a receptacle installed on the shooting line.

LW support assembly:

- B00734C (includes base, two LW supports, and rifle holder)

Support specifications / dimensions:

- Post minimum height 185mm to maximum 235mm
- Top plate 120mm x 30mm, with non-slip rubber surface

Fixed base support:

- Height 45mm

Supplied by approved manufacture/FIS

Images in Annex 1



7 Specifications for Shooting System for Vision Impaired Athletes

The rules for Para Biathlon shooting systems are described in art. 12332.3 of the ICR.

General and product specifications for shooting systems for vision impaired athlete are described in art. 12332.3.3.

7.1 EcoAims E-BSS2006

The EcoAims E-BSS2006 shooting system for vision impaired athletes is currently the only approved shooting systems FIS competitions. It is produced by EkoAims of Finland and includes the following components:

| | |
|---|--|
| <ul style="list-style-type: none"> • E00268A Optical (electronic) rifle unit with wooden stock |  |
| <ul style="list-style-type: none"> • E00259B EBSS rifle cover bag |  |

| | |
|--|--|
| <ul style="list-style-type: none"> E00267A E-Di2 display unit. |  |
| <ul style="list-style-type: none"> E00294A Weatherproof box (pipe inside or outside) containing the E-Di2 display unit |  |
| <ul style="list-style-type: none"> E00295B Display cover bag |  |
| <ul style="list-style-type: none"> E00038A Power supply for E-Di2, 24VDC 1000mA. |  |
| <ul style="list-style-type: none"> E00275A Transponder Reader (for target reset) |  |
| <ul style="list-style-type: none"> E00278A Transponder chip - ID tags worn on the wrist of each athlete used to reset targets |  |
| <ul style="list-style-type: none"> E00188A Silenta headphones (2 per set), noise insulated. |  |
| <ul style="list-style-type: none"> E00662A Rifle support (holds the rifle in place at the firing line when not in use) |  |
| <ul style="list-style-type: none"> E0041A biathlon target 350, 5 x 30 mm spots, without battery |  |

| | |
|--|--|
| <ul style="list-style-type: none"> • E00805A BT-350/30L biathlon target, 5 x 30 mm spots, rechargeable, with 24V lead battery |  |
| <ul style="list-style-type: none"> • E00330B EBSS biathlon target cover bag |  |
| <ul style="list-style-type: none"> • E00263B Lead battery charger for BT-350 target, 24 VDC 500mA. |  |
| <ul style="list-style-type: none"> • E00037A Target control cable for BT-350 target and E-Di2, XLR 4-pin - Neuricon. |  |
| <ul style="list-style-type: none"> • E00510A Legs for BT-350 biathlon target (short) |  |
| <ul style="list-style-type: none"> • B00761A Biathlon target legs folding assembly |  |
| <ul style="list-style-type: none"> • E00730A User manual, English. | |

7.2 Updates, settings, and additional specifications:

While the operation of the EcoAims shooting system has not changed, the system has undergone a series of software, hardware and component updates since it was first introduced. The following is a current list of updates and developments that are required for the proper operation of the system. The manual will be updated from time to time to reflect the latest updates. Range owners will need to ensure that their VI Shooting equipment is up to date to maintain certification. The following apply primarily to systems acquired before 2014.

7.2.1 Rifle Software

- The optical rifles contain software that must be updated from time to time.
- Currently approved rifle software version(s) are:



- 3v_36_ver49 or
- 3v_36_ver50
- Check with Kurvinen / EkoAims to verify the software version installed in rifles and record this in the equipment registry.

7.2.2 Display Unit

There are two variations of the E00267A E-di2 display units, a standard version that is designed to operate on a standalone basis (tr_v.01b09 or tr_v.01b10), and a version that is designed to work with an arcnet network and is used in association with electronic scoring (ah_v0.1b15 or ah_v0.1b16). The latter only applies for Paralympic Winter Games and is supplied and operated by Kurvinen. Both are approved for FIS competition.

7.2.3 Targets

The shooting hit area diameter for FIS competition is **21mm** and targets must be set accordingly

The following target model numbers are approved for FIS competition:

- E0041A (without battery)
- E00260A (with battery)

7.2.4 Infrared light emitting target diodes

Each of the 30mm target spots contains infrared light emitting diodes that are read by the optical rifle. The quality of the light emitting diodes has changed over the years and the LED model has been upgraded in 2013 to improve operation in brighter sunlight conditions. Therefore, for certification purposes:

- Target diodes must be newer than 2013.
- When upgrading diodes in older target models it must be confirmed that the LED power supply as the new LEDs require more power than the older models to work perfectly.

7.2.5 Headphone Calibration

The headphones are worn by the athlete when shooting and used to listen to the tone during aiming. These plug into the display box. Since athletes will use different shooting lanes and rifles during different shooting bouts during competition, it is necessary that all headphones used during competition are calibrated for the same sound level:

- Sound level at headphone must be set at 90db +/- 5db at maximum tone frequency when aiming at the middle of target aperture.



- Settings must be checked and calibrated prior to training and competition using an audiometer.

7.2.6 Additional components

The following target components are also supplied by EcoAims as part of the E-BSS2006 equipment set but are used for indoor training rather than in competition and are not required for range equipment certification:

- E00711A TAR-100/30L, electronic target, 1 x 30 mm spot, rechargeable via mini USB.
- 60228 USB power supply, including plugs for EU, UK, US, AU sockets (type C, G, A, O).
- E00319A USB cable, A – mini B.

7.3 Special Requirements for Electronic Scoring Systems

In addition to the standard requirements for biathlon targets, when used, electronic scoring systems must comply with the following:

1. Data Feed Distribution
 - The system must be able to transfer data to multiple operation points.
 - Such as timing, data processing and TV (including graphics) production.
2. Interface Hardware
 - All data flow other than system-internal processes must use a RS- 232 interface. No buffering or handshake controls are required;
3. Communication Protocol
 - In order to process and log the data feed with standard PC equipment, a simple ASCII-coded protocol must be used.
 - The following information must be transmitted.
 - Assignment of start number to shooting lane, including A to D indicators for relay competitions;
 - Automatically generated data must include:
 - competitor arrival at shooting lane (from time of bib / lane assignment)
 - start of shooting;
 - target hits – (including target plate numbers 1 to 5)
 - missed shot(s) – hit outside diameter shooting ring
 - missing shots (less than 5 hits/shot taken on target)



- end time of shooting bout (last hit/shot taken on target)
 - Important data such as bib number, shooting lane, total misses, missing shots and shooting time must be able to be interpreted from this feed by results software
4. Transmission Delay

The maximum delay, from when a target hit is registered by the target sensor system until the complete transmission via the data output line, must not exceed 200ms.
 5. Target Reset

Automated target reset must occur 8 seconds after 5th shot registered on the target or 40 seconds after the first shot registered on the target in the event of a missing shot.
 6. Backup Systems (100% redundancy)

To guarantee reliable data feed during major international events, the target system must have two independent processing systems, and therefore must provide two data feeds (target to processing unit), two separate central unit cards, and two independent data feeds from the central unit cards to the timing, data processing and TV graphics systems.

8 Range and Penalty Loop Layout Specifications

8.1 General Requirements

Para Nordic competitions include both sports (cross-country skiing and biathlon) which are typically held during the same event with most Para Nordic athletes competing in both sports. Therefore, stadium layout normally requires consideration of both biathlon and cross-country skiing formats.

Venues with established biathlon ranges are ideal if the terrain and stadium access is suitable for sit ski courses and enough stadium space exists for cross-country formats. In general, Para Biathlon range and penalty loop layout, operations, and equipment requirements are consistent with IBU principles with adaptations and specific equipment requirements for Para Biathlon.

Cross-country skiing venues may also be used where there is enough space to install the Para Biathlon range and 150m/100m penalty loop in addition to cross country requirements. The range component requires a minimum of 26.5m x 72m for the World Cup range (12 LW + 12 VI lanes), or 26.5m x 77.5m (14 LW + 12 VI lanes) for World Championships and 26.5m x 88.5m (18 LW + LW 12 VI lanes) Paralympic Winter Games **plus** space for a 150m penalty loop within 60m after the exit from the range.

Stadium and Range layouts where the viewing audience may view the start, shooting, penalty loop and finish from the same viewing point (stands) are preferred, however a short distance between the stadium and range is acceptable and would be considered for approval.

Special consideration should be given to accessibility for athletes, spectators and media.



8.2 Para Biathlon Range Layout

The rules for Para Biathlon shooting range layout are listed in art. 12332.1 of the ICR. These include rules for:

- General layout, orientation, safety and number of shooting lanes for different levels of competition
- Shooting distance
- Range entry, exit, and related markings
- Shooting ramp
- Shooting ramp and target level
- Team staff, officials, and media areas
- Shooting lane width, marking, and numbering
- Shooting mats
- Targets and target placement
- Target maintenance
- Target background
- Target diameter
- Wind flags
- Rifle racks
- Video control

Supplementary requirements described in this manual include:

- Location of range clock
- Specifications for backwalls used at PWG or when required (for safety) at other venues.
- Position of shooting results displays above targets (PWG)

8.2.1 Specifications for range layout and target setup are illustrated and can be found in Annex 1.

Range components that must be provided in addition to the shooting systems include:

- Firing line board
- Shooting lane dividers
- Shooting mats



- Wind flags
- Time of day clock
- Lane divider signs & numbers
- LW range shooting boards
- VI range shooting boards
- Air tanks & adaptors
- Rifle Racks
- Rifle check table
- Results board
- Zeroing frames, backing inserts and paper
- Range cameras
- Range open / closed flags
- Range signage
- Range marking cones

Detailed specifications and drawings for most components can be found in Annex 1 and included in Annex 2.

Procedures and specifications for range operations including set up, maintenance, competition, take down, scoring and competition control are described in the Para Biathlon Operations Manual.

8.3 Penalty Loop Layout

The rules for Para Biathlon penalty loop layout are listed in art 12332.2 of the ICR. These include requirements that:

- The entrance of the penalty loop must be no more than 60m skiing distance from the exit of the range
- Variable penalty loop lengths are required and include (measured along inside perimeter):
 - 80m for Biathlon Sprint Pursuit (all classes)
 - 100m for Sit Ski classes
 - 150m for Standing and Vision Impaired classes
- Width must be at least 6m wide



- The entrance/exit opening must be at least 15m long and v-boards or equivalent must be used to demarcate the penalty loop so that the entry and exit is clear and short cuts are not possible.

Refer to Annex 1 for detailed drawings and layouts for penalty loop setup. The operations manual includes drawings for penalty loop control and video camera placement.



9 Administration

The administration of the Para Biathlon range and equipment certification process and standards is the responsibility of FIS, IBU and the Sub Committee Para Nordic.

This manual will be updated from time to time and the most current version will be maintained on the FIS website under the 'Documents' section.

9.1 Contacts

FIS Para Nordic Race Director:

Georg Zipfel: zipfel@fis-ski.com

Para Biathlon Coordinator:

Tomi-Pekka Riihivuori: tomi-pekka.riihivuori@ibu.at

Para Nordic Coordinator:

Elke Gundermann: gundermann@fis-ski.com

Annex 1

Range and Penalty Loop Specifications and Drawings

Table of Contents

| | |
|--|---------------------------|
| <u>Range Layout</u> | <u>3</u> |
| <u>Shooting Lanes</u> | <u>15</u> |
| <u>Target Placement</u> | <u>17</u> |
| <u>Target Area</u> | <u>23</u> |
| <u>Penalty Loop</u> | <u>30</u> |
| <u>Lane Signage</u> | <u>34</u> |
| <u>Wind Flags</u> | <u>44</u> |
| <u>Firing Line & Equipment</u> | <u>47</u> |
| <u>Other Equipment</u> | <u>59</u> |

Range Layout

Art. 12332.1.1

24 - 26 Lanes Required for WC or WSC

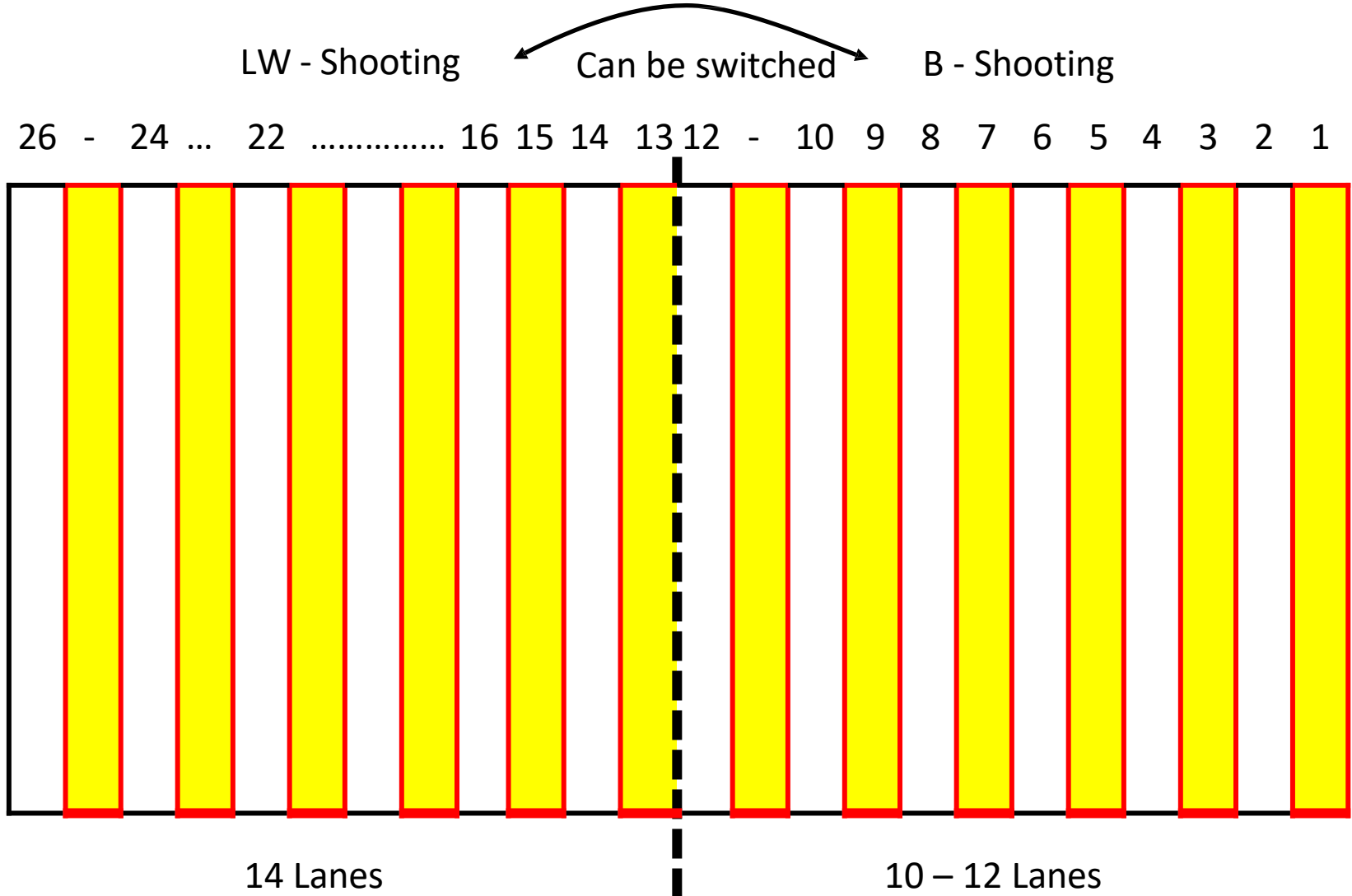

Art. 12332.1.2

30 Lanes Required for PWG

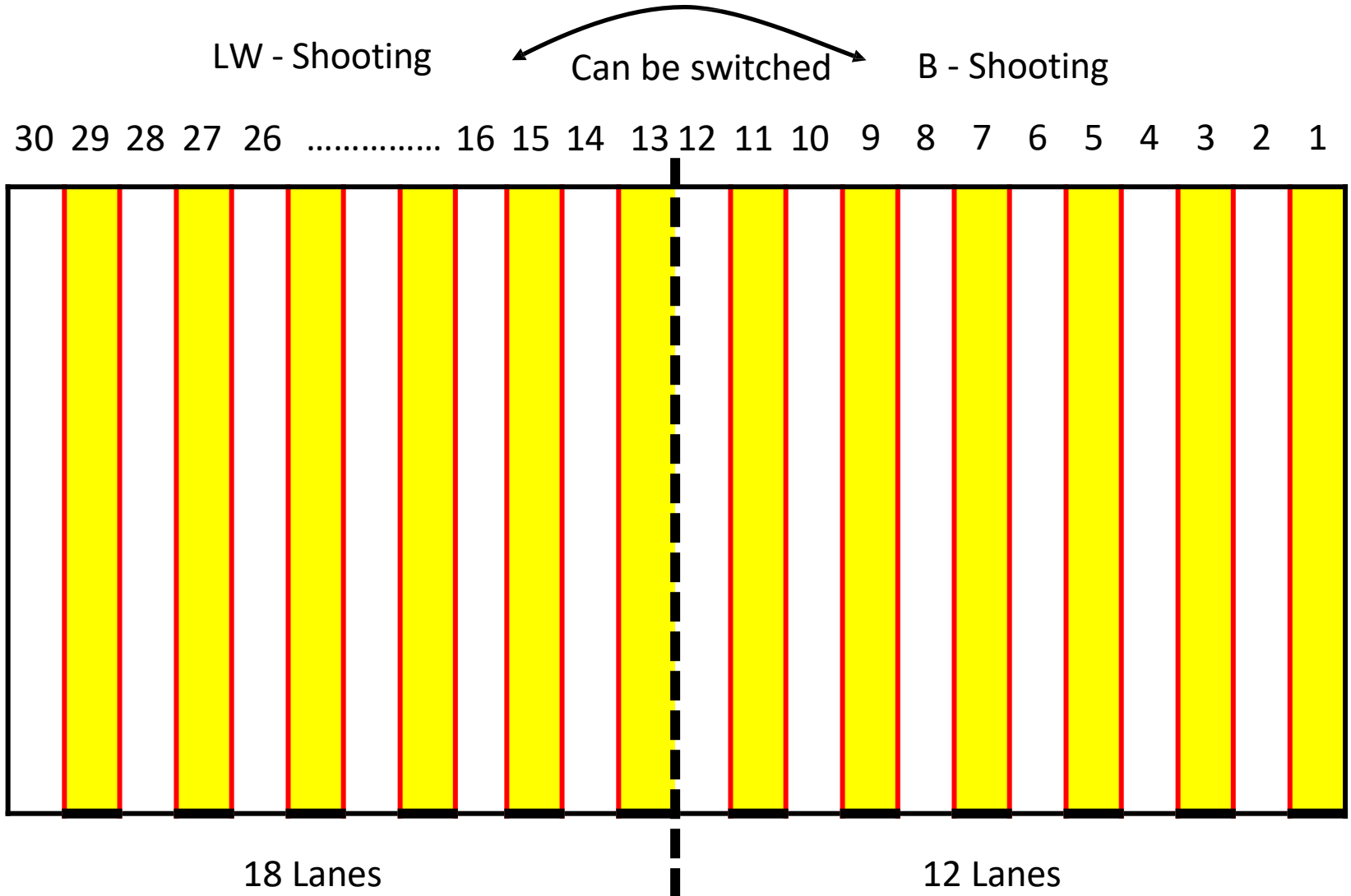

Art. 12332.1.8

Safety Zones

Other safety requirements by local rules.

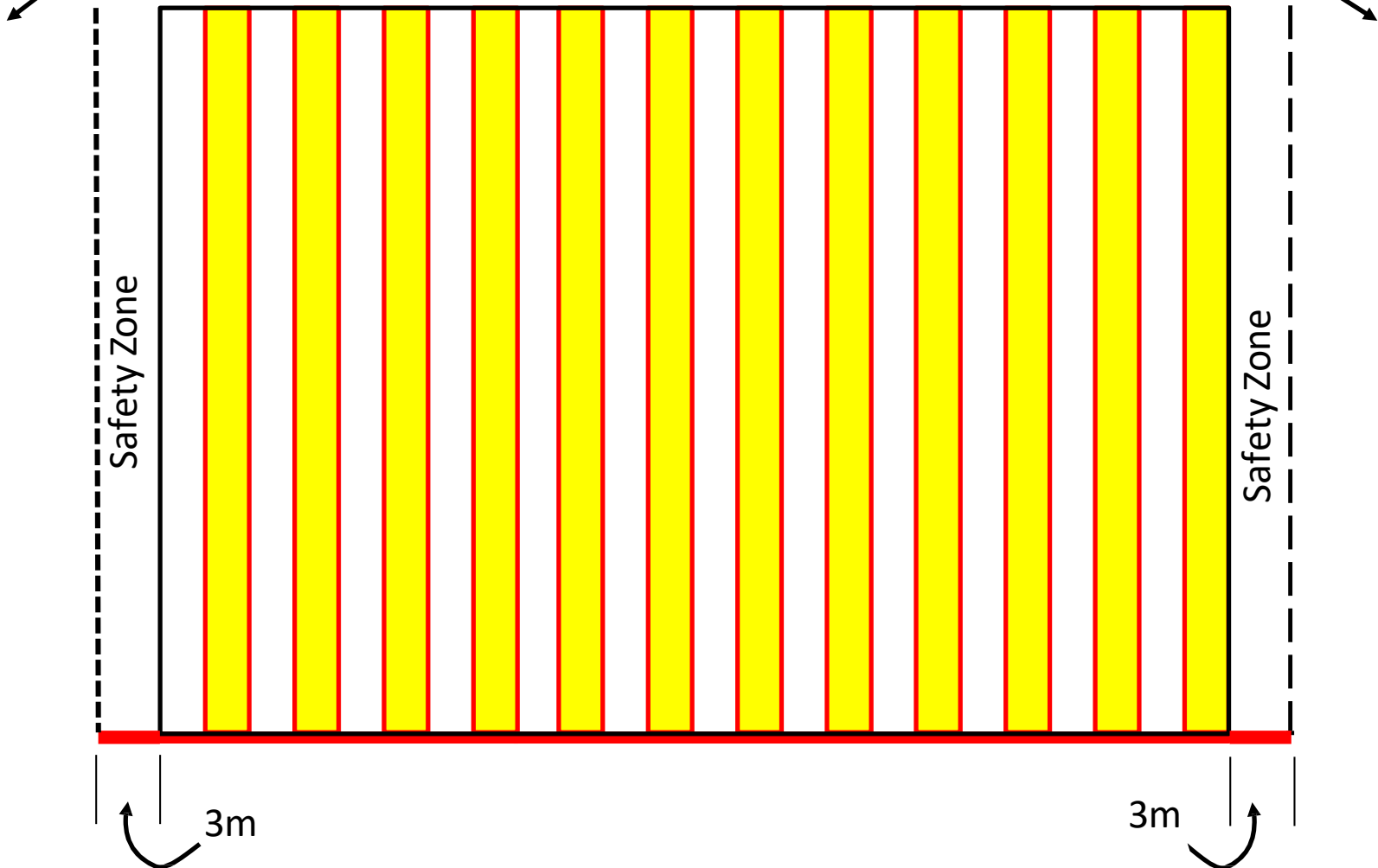

Art. 12332.1.5, 12332.1.7,
12332.1.8

Range Boxes

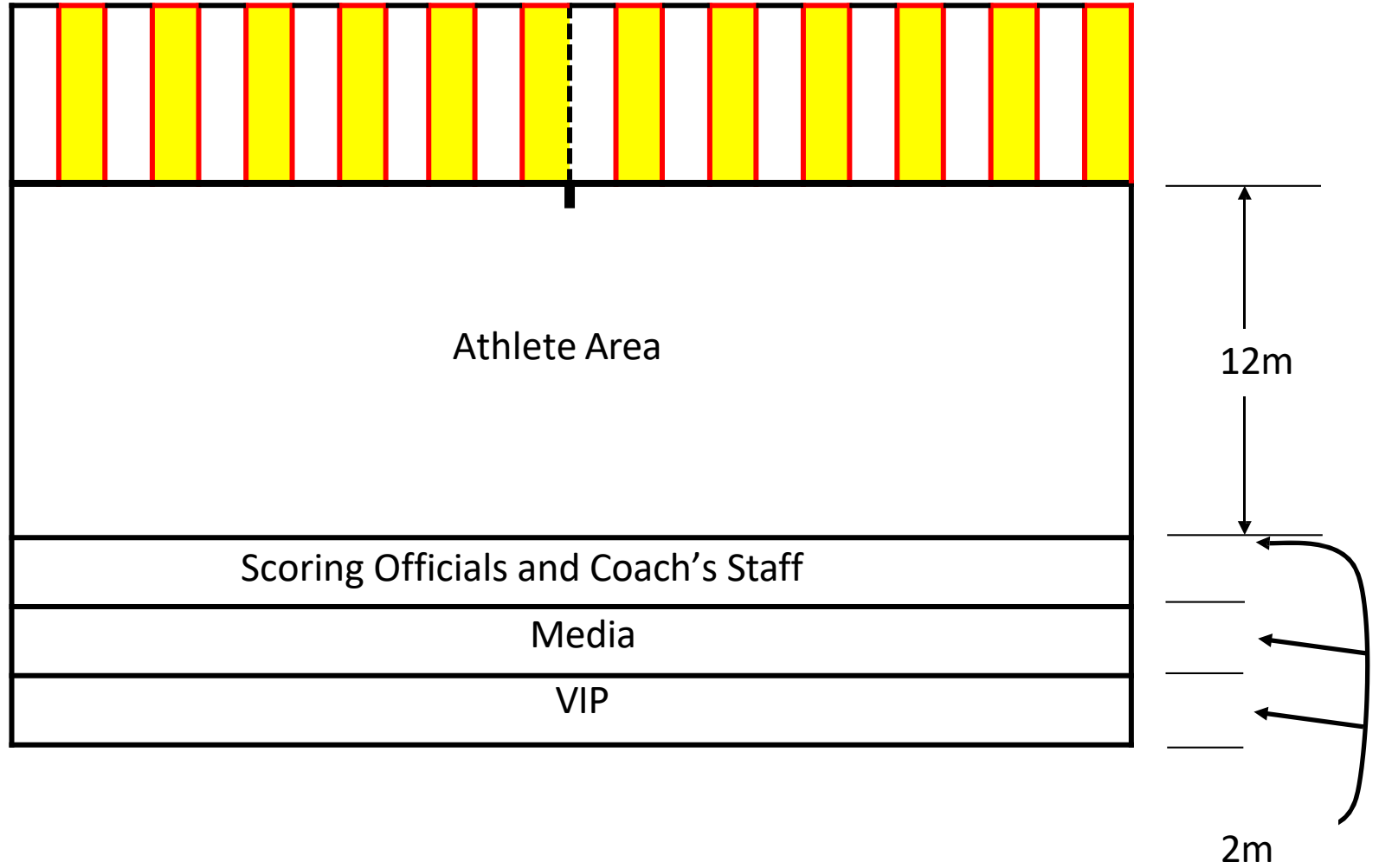

Art. 12332.5.3

B-Guides Standing Line

B - Shooting

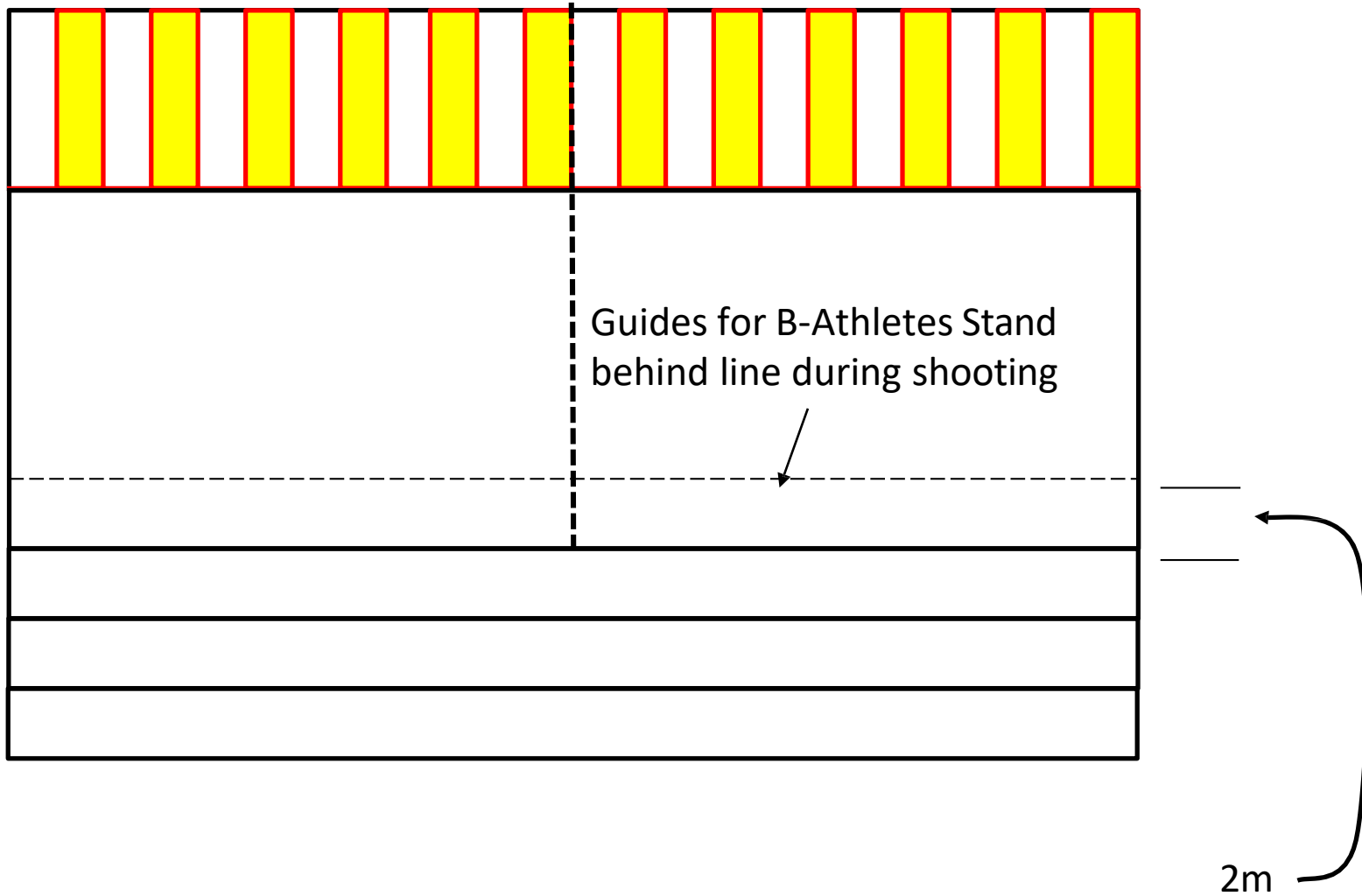

2m

Art. 12332.1.5, 12332.1.7,
12332.1.8

Range Area Required for 26 Targets

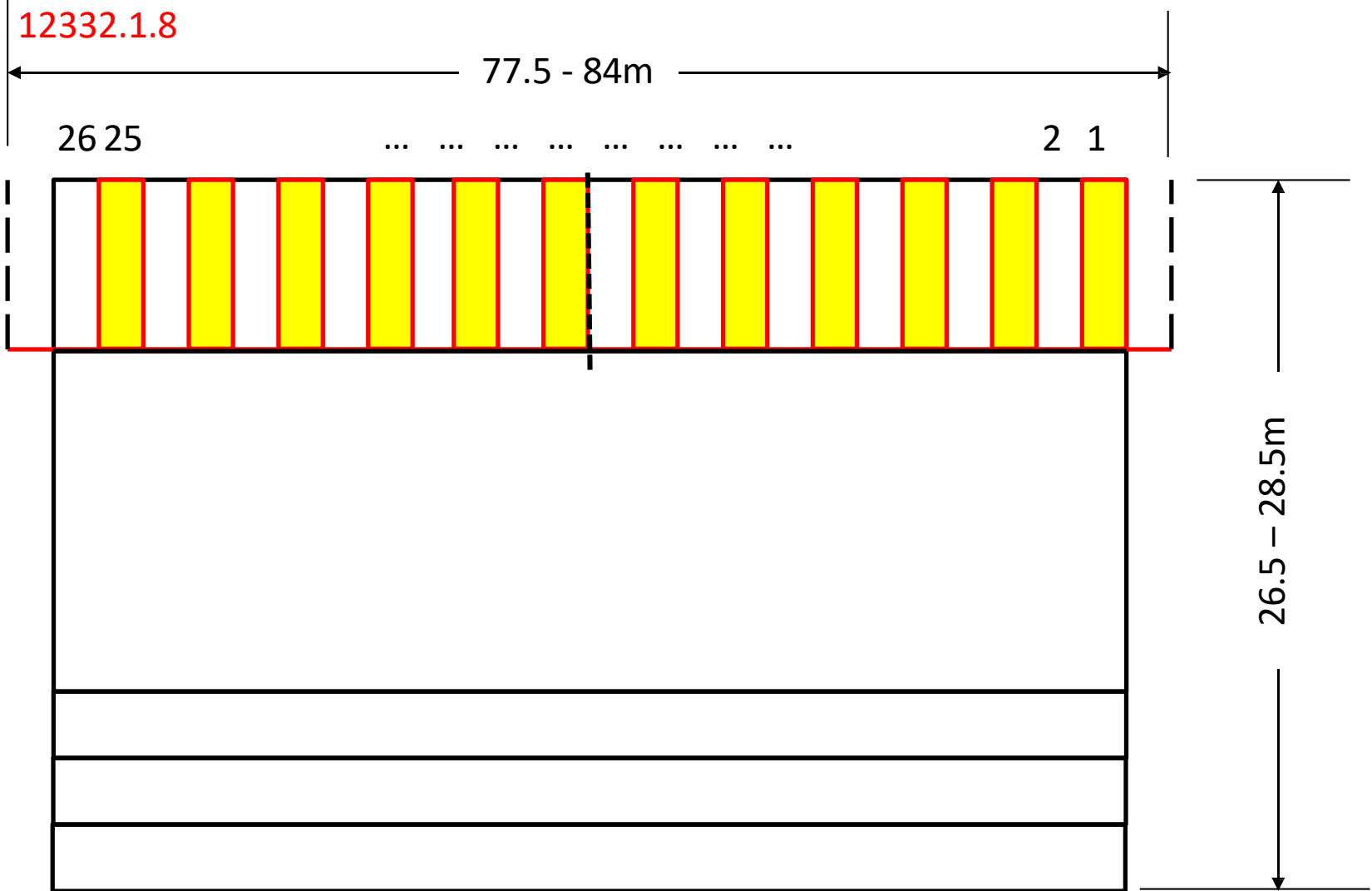

Art. 12332.1.5, 12332.1.7,
12332.1.8

Range Area Required for 30 Targets

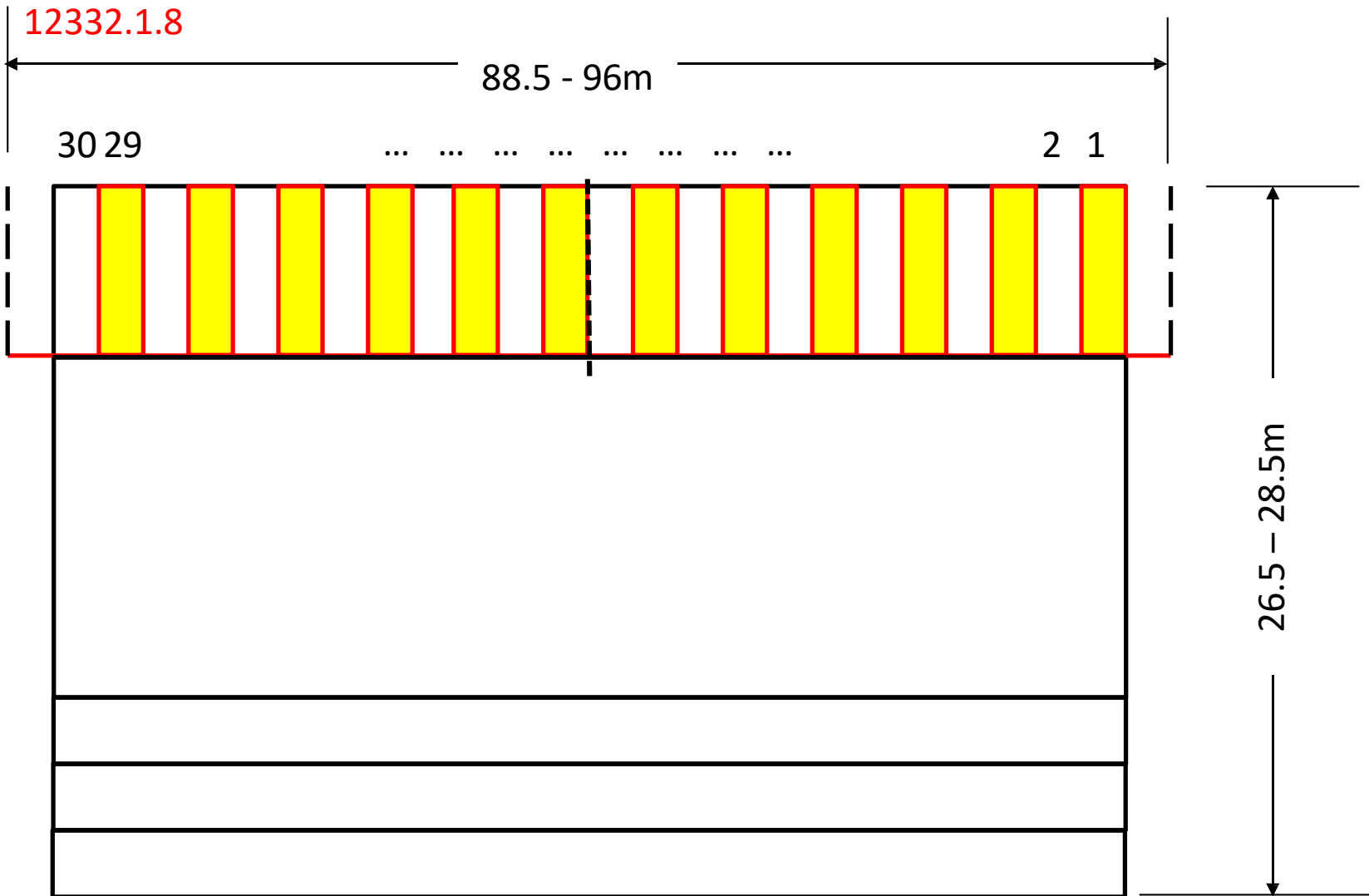

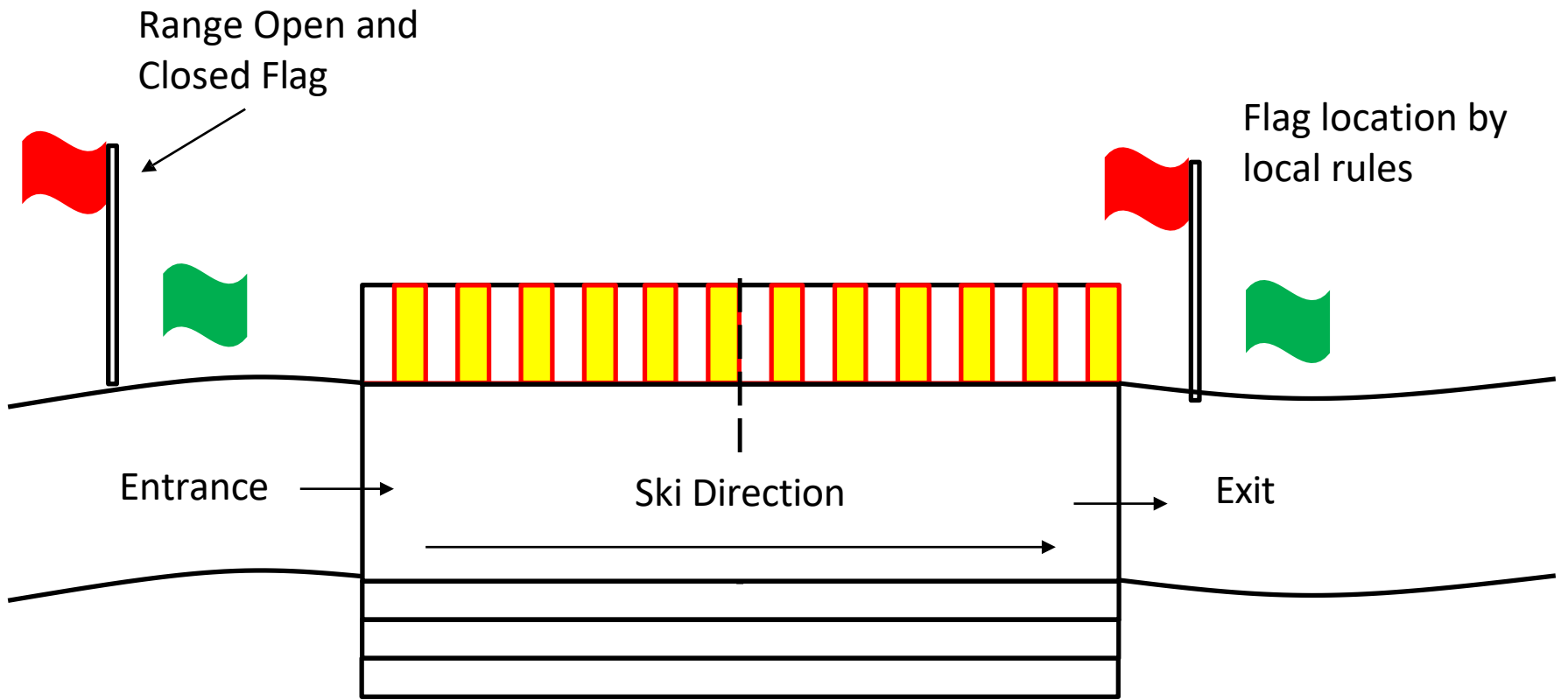

Range Flags

Art. 12332.1.4

Prohibition Zone

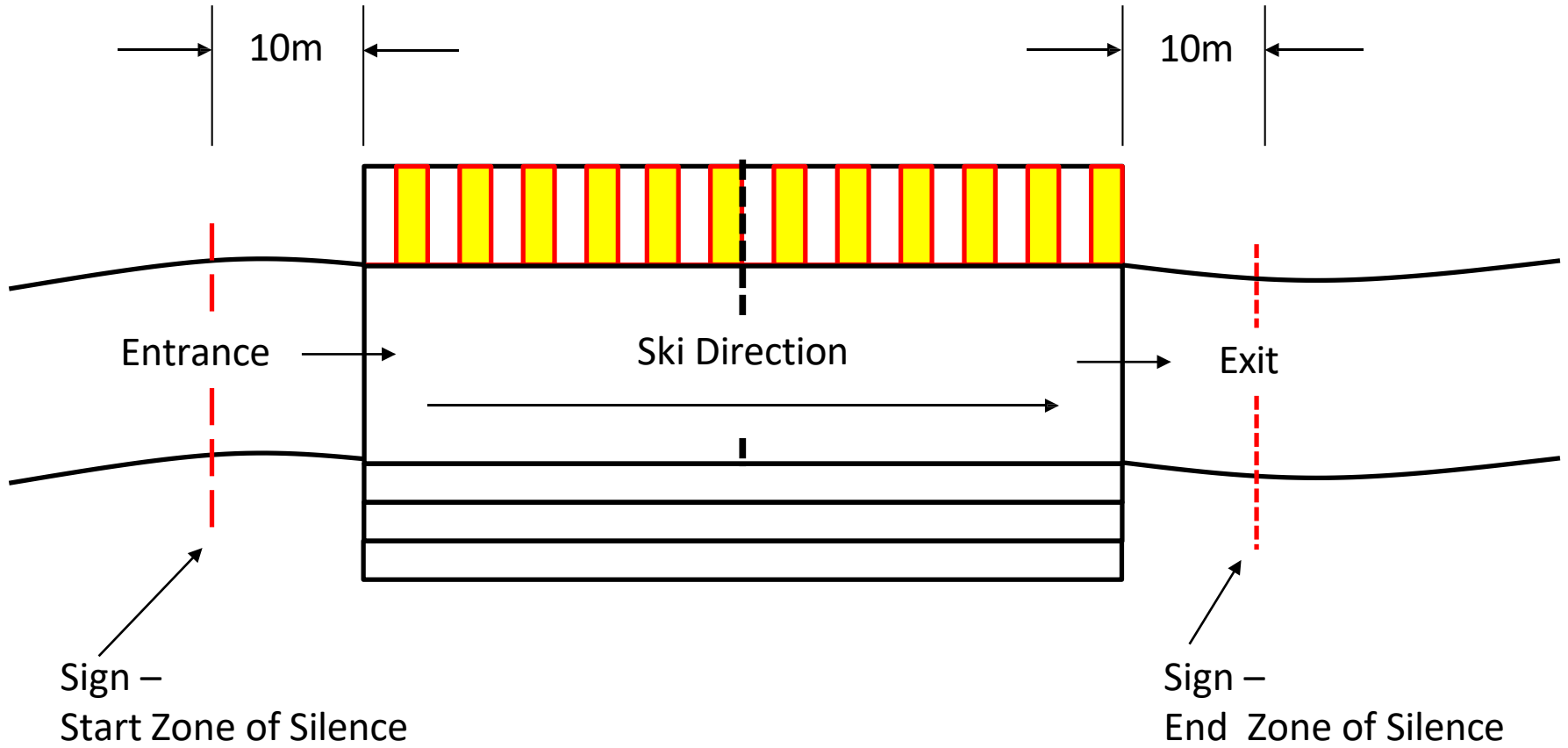

Neutralization Zone

LW - Shooting

B - Shooting

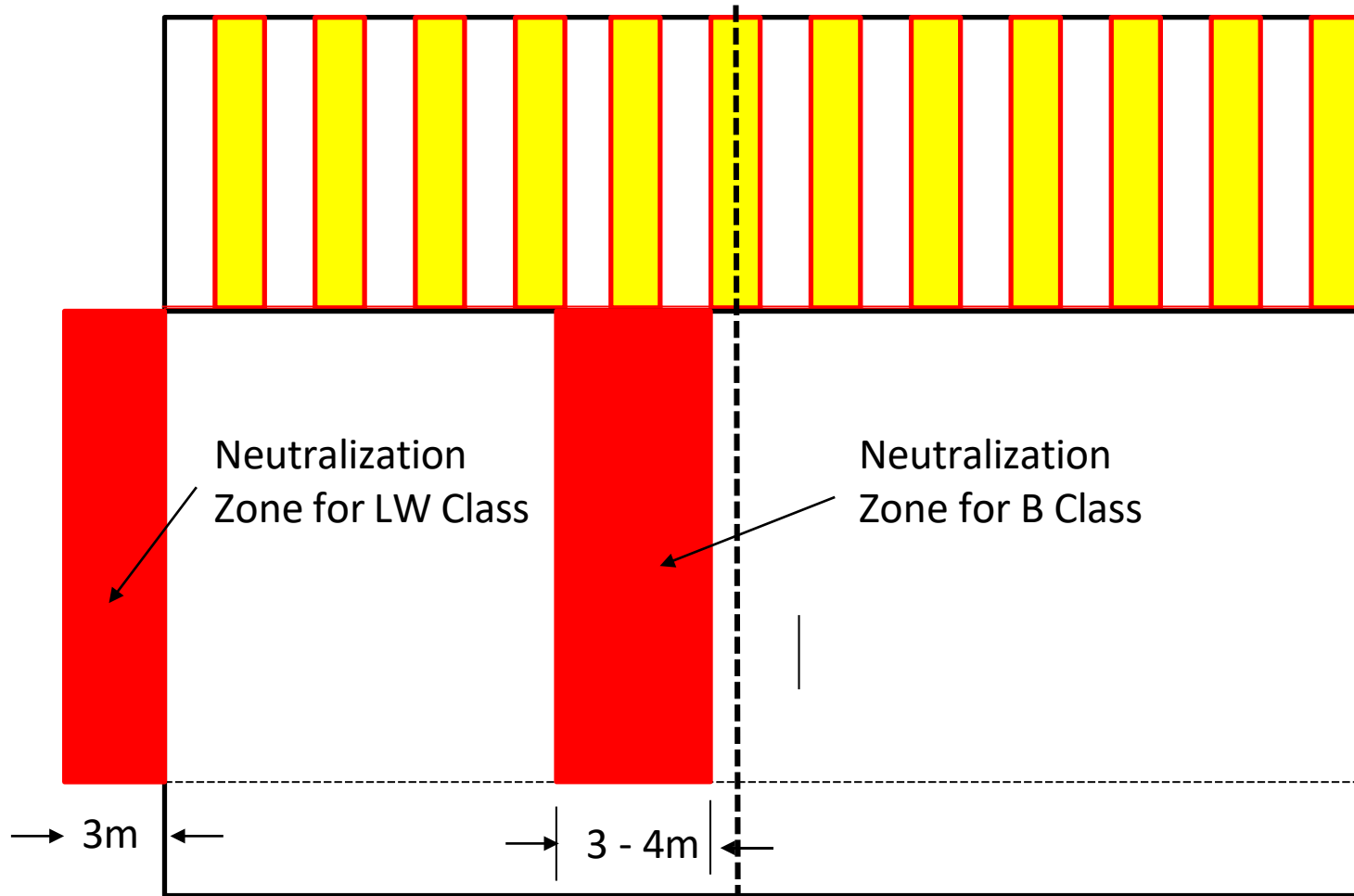

Neutralization
Zone for LW Class

Neutralization
Zone for B Class

→ 3m ←

→ 3 - 4m ←

Requires Team of 1 - 2 People

Shooting Lanes

Art. 12332.1.9

Lane Widths

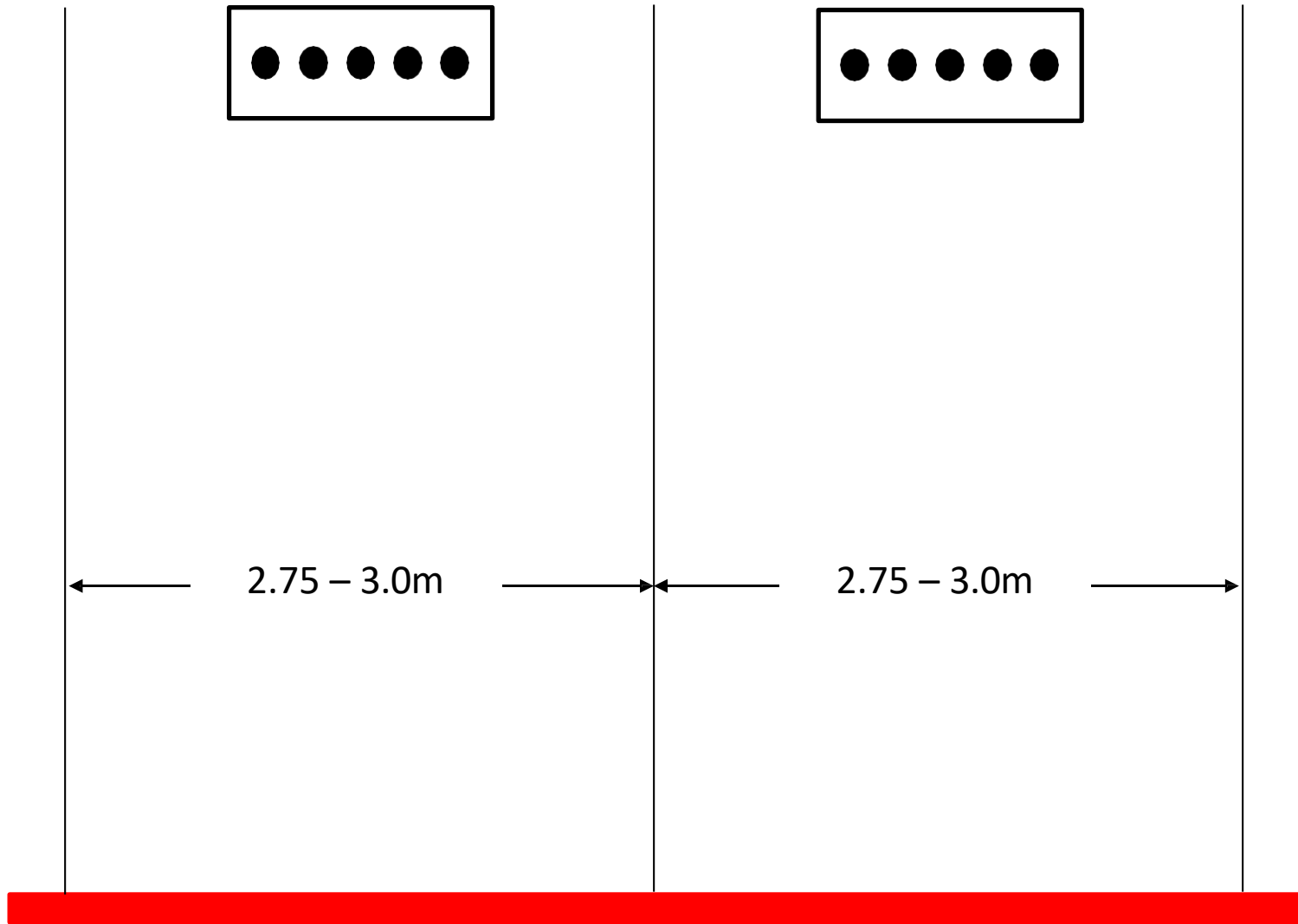

Target Placement

Art. 12332.1.14

Target Placement

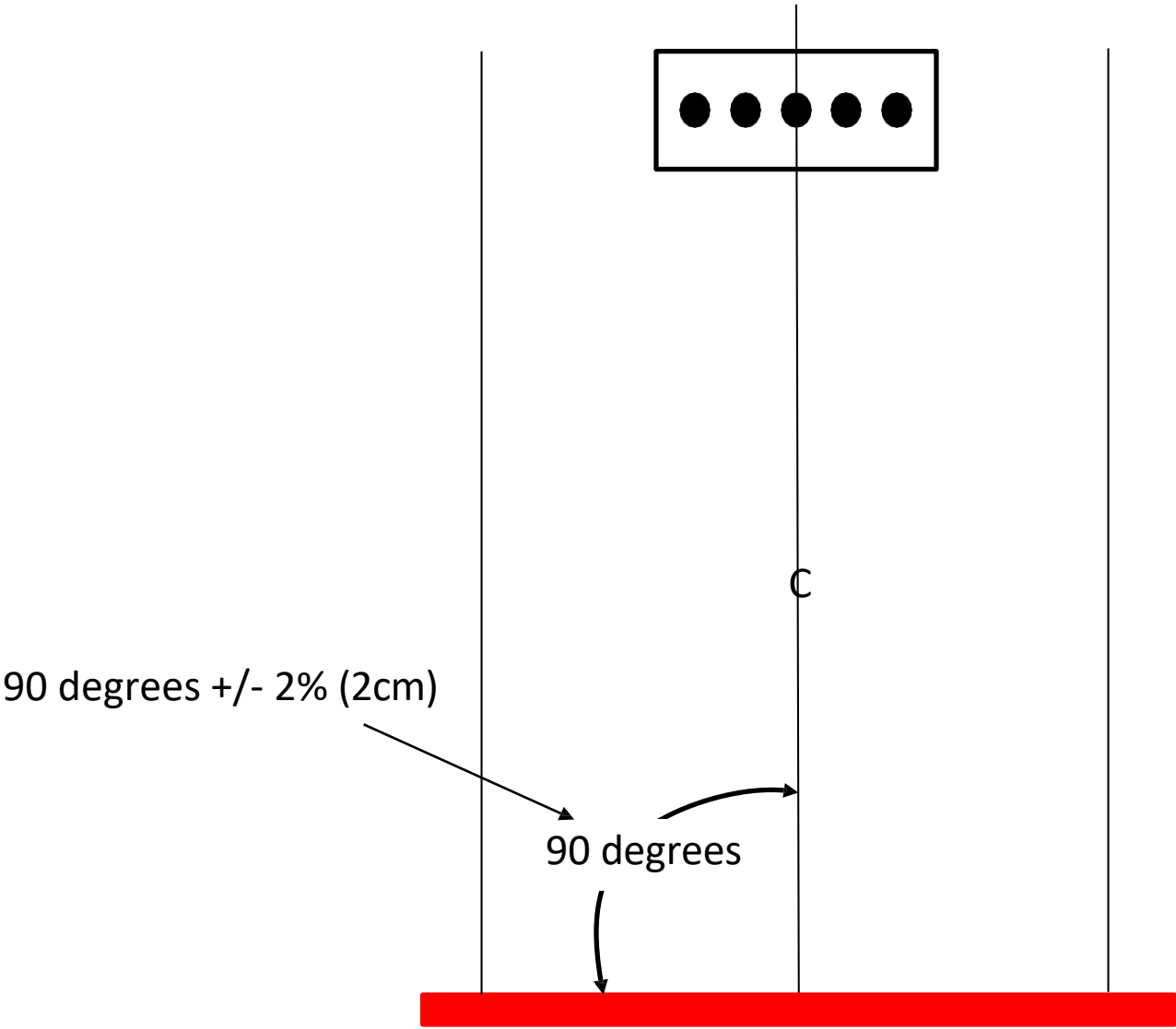

Art. 12332.1.3

Range when using targets with short legs

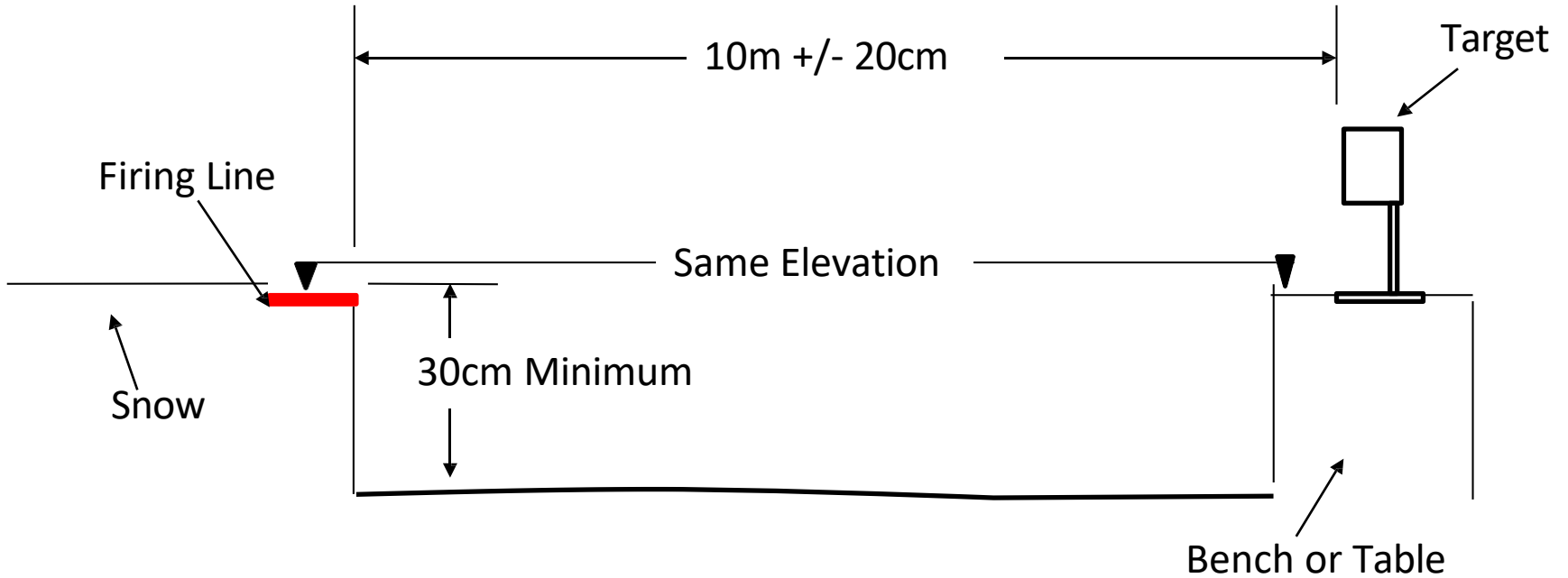

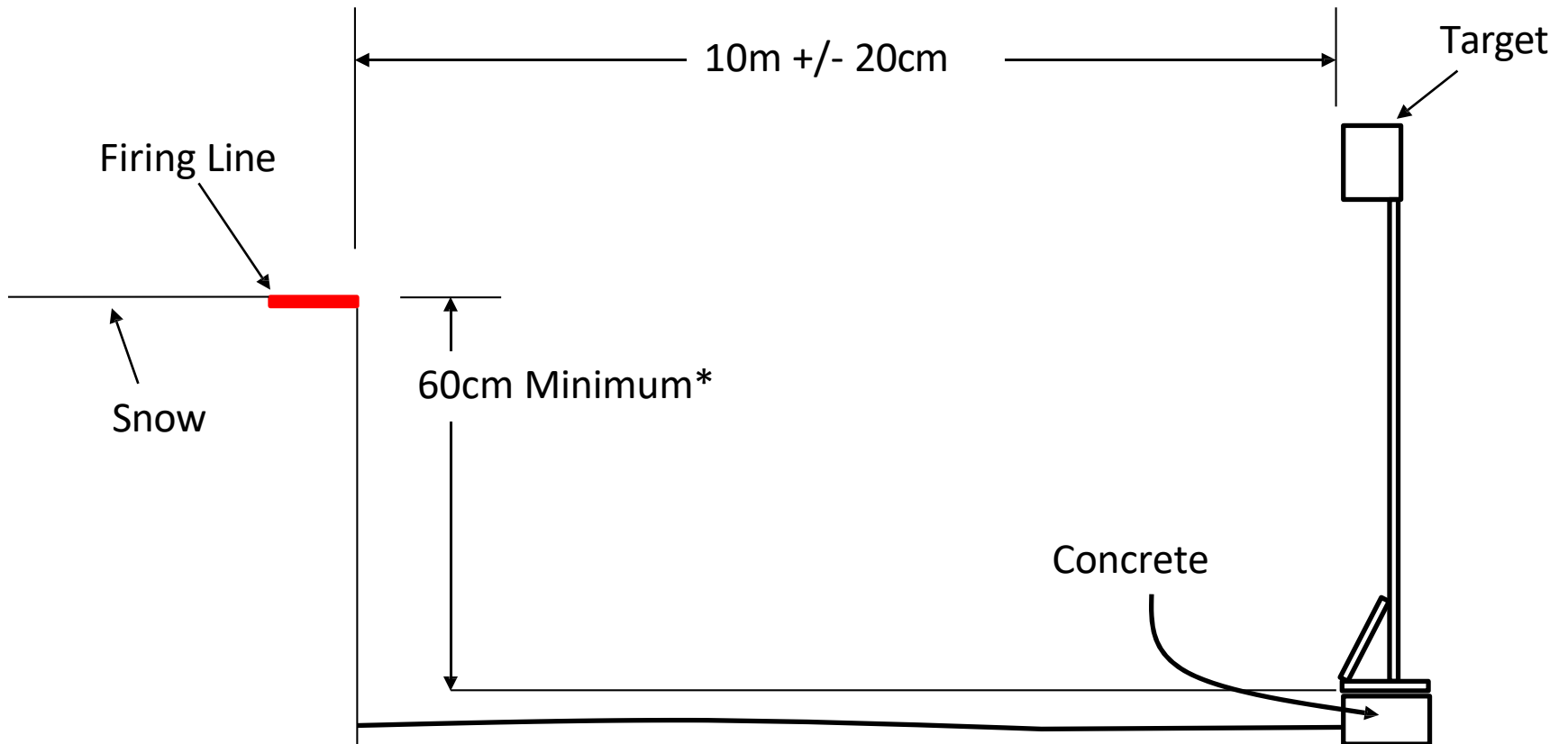

Range when using targets with manufacture folding legs

* Requires design and approval by manufacture and FIS.

Art. 1233.1.14

Target Height Relative to Firing Line

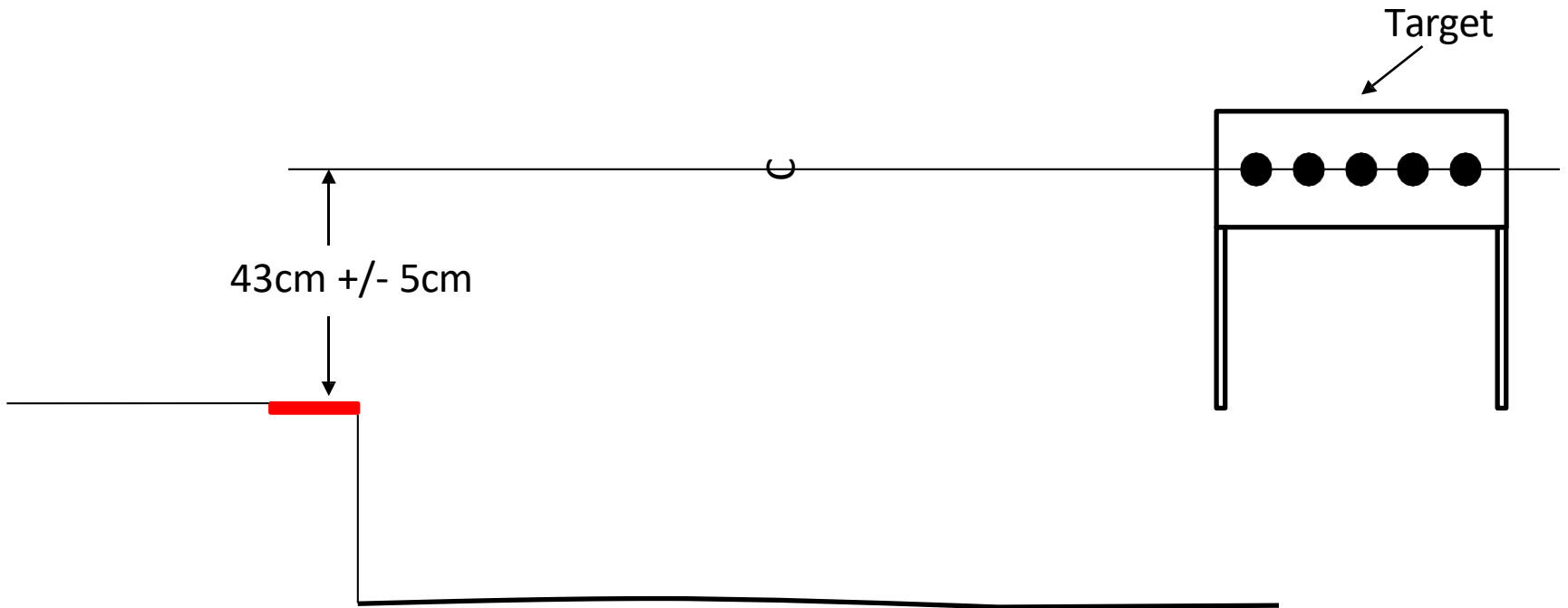

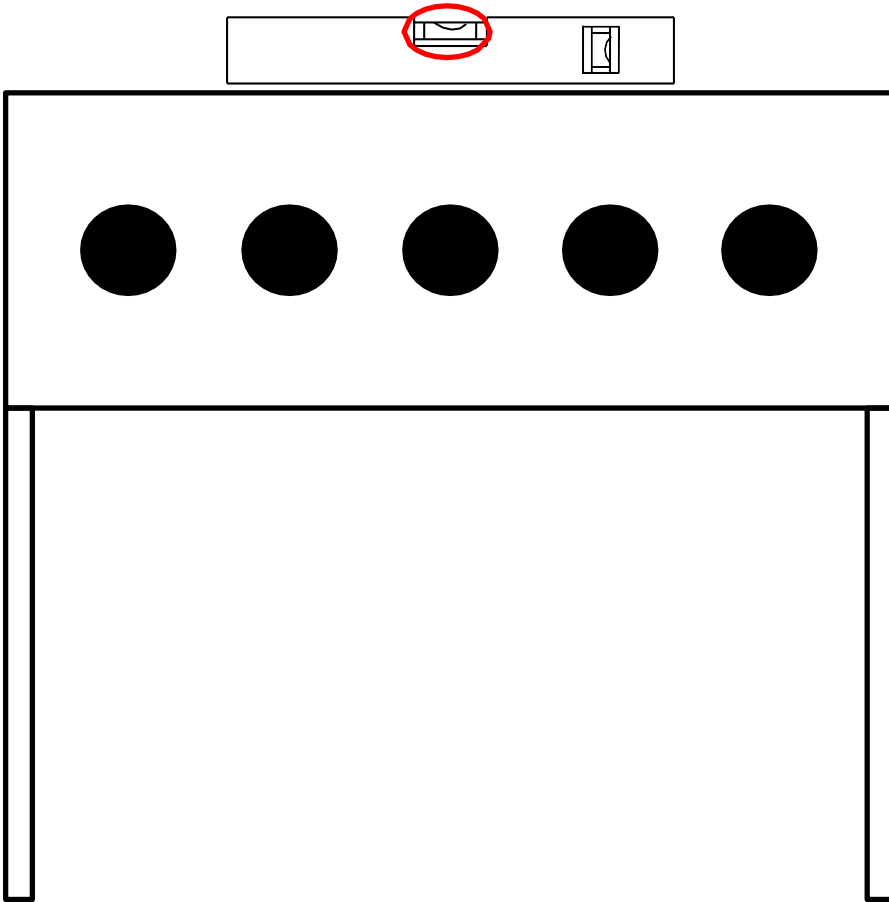

Target Levelled in Horizontal

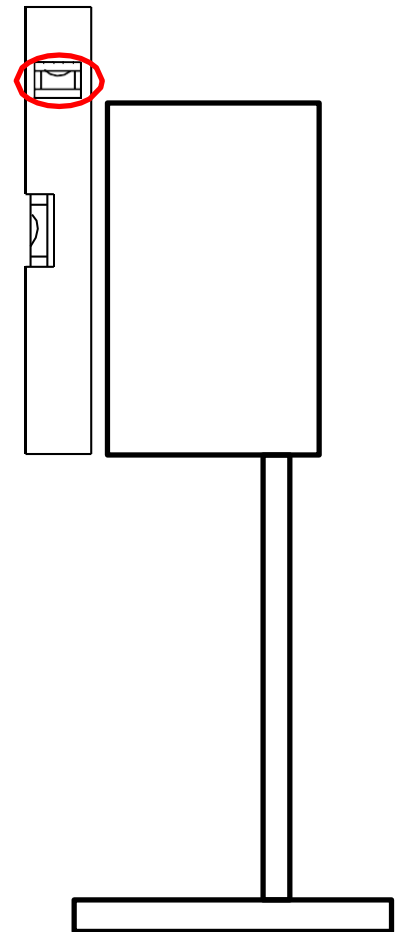

Target Levelled in Vertical

Target Area

Art. 12332.1.15

Target and Area for WC

From ground to 1m
above targets to be
white.

Target

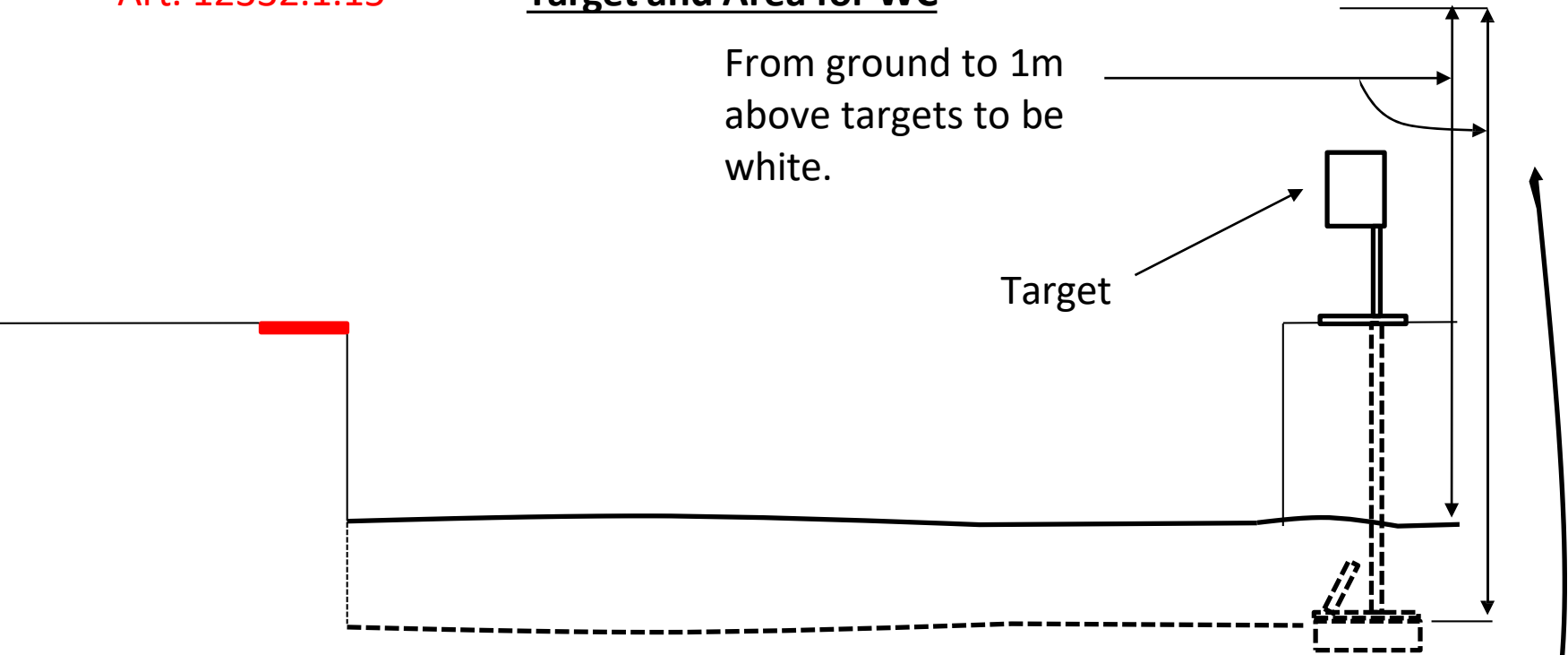

Wall behind not
required.

Or

White out of 50m
targets required if 50
range is used.

50cm minimum

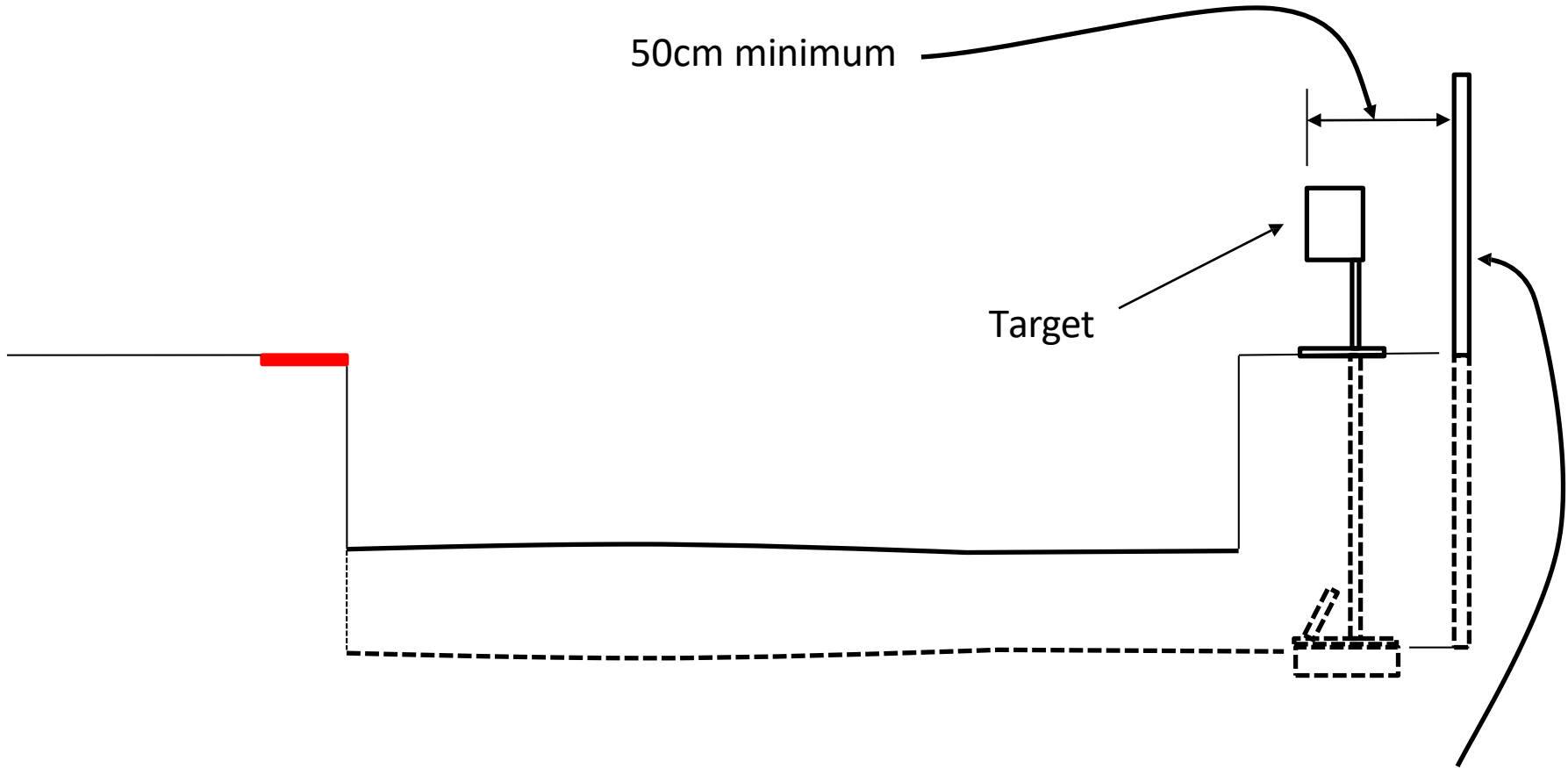

Target

Target and Area for WSC

Wall behind required,
designed for wind load.

Or

White out of 50m
targets required if 50
range is used.

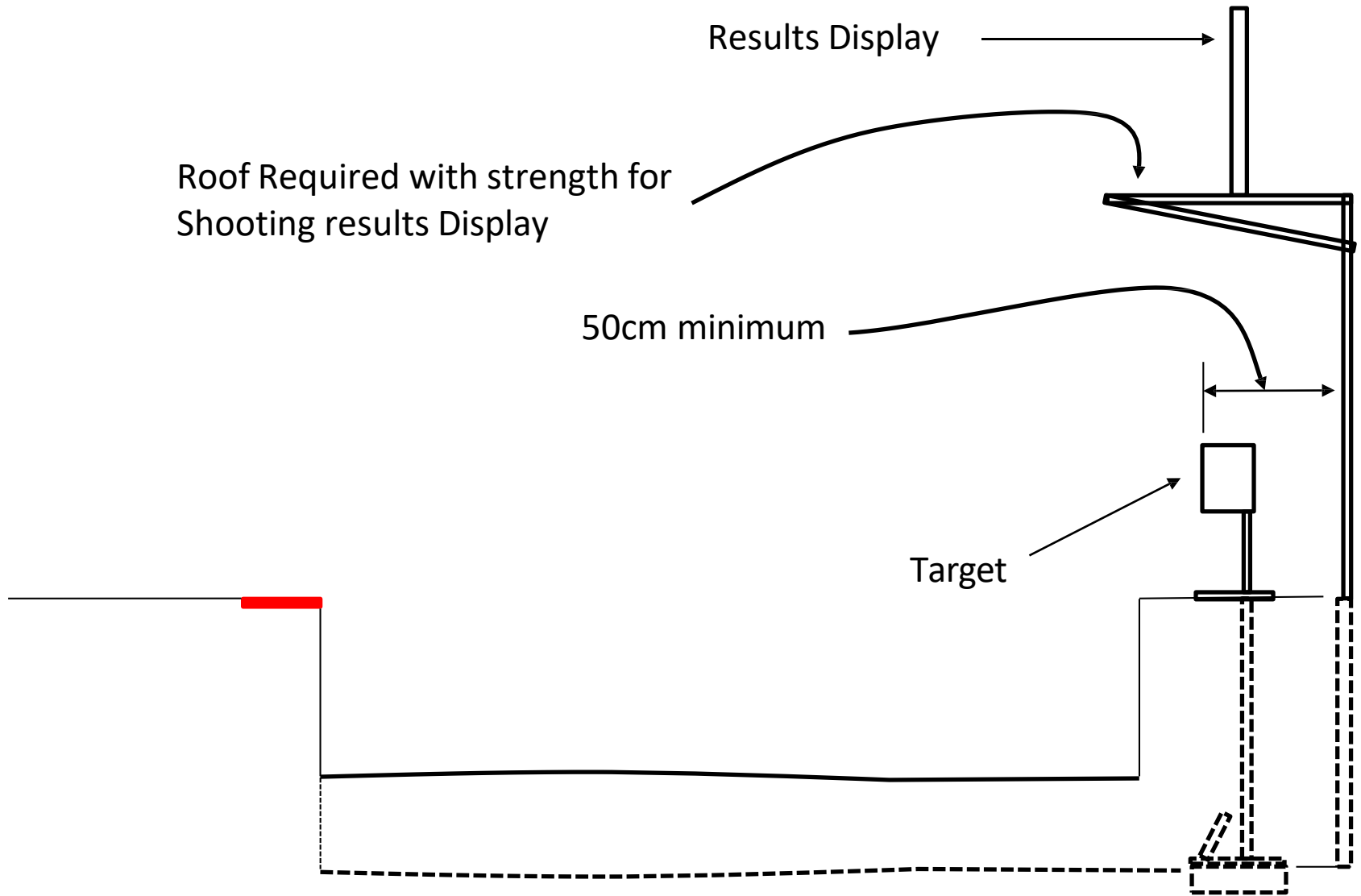

**When Target Roof Planned for PWG
Requires Prior Approval by FIS and Engineers**

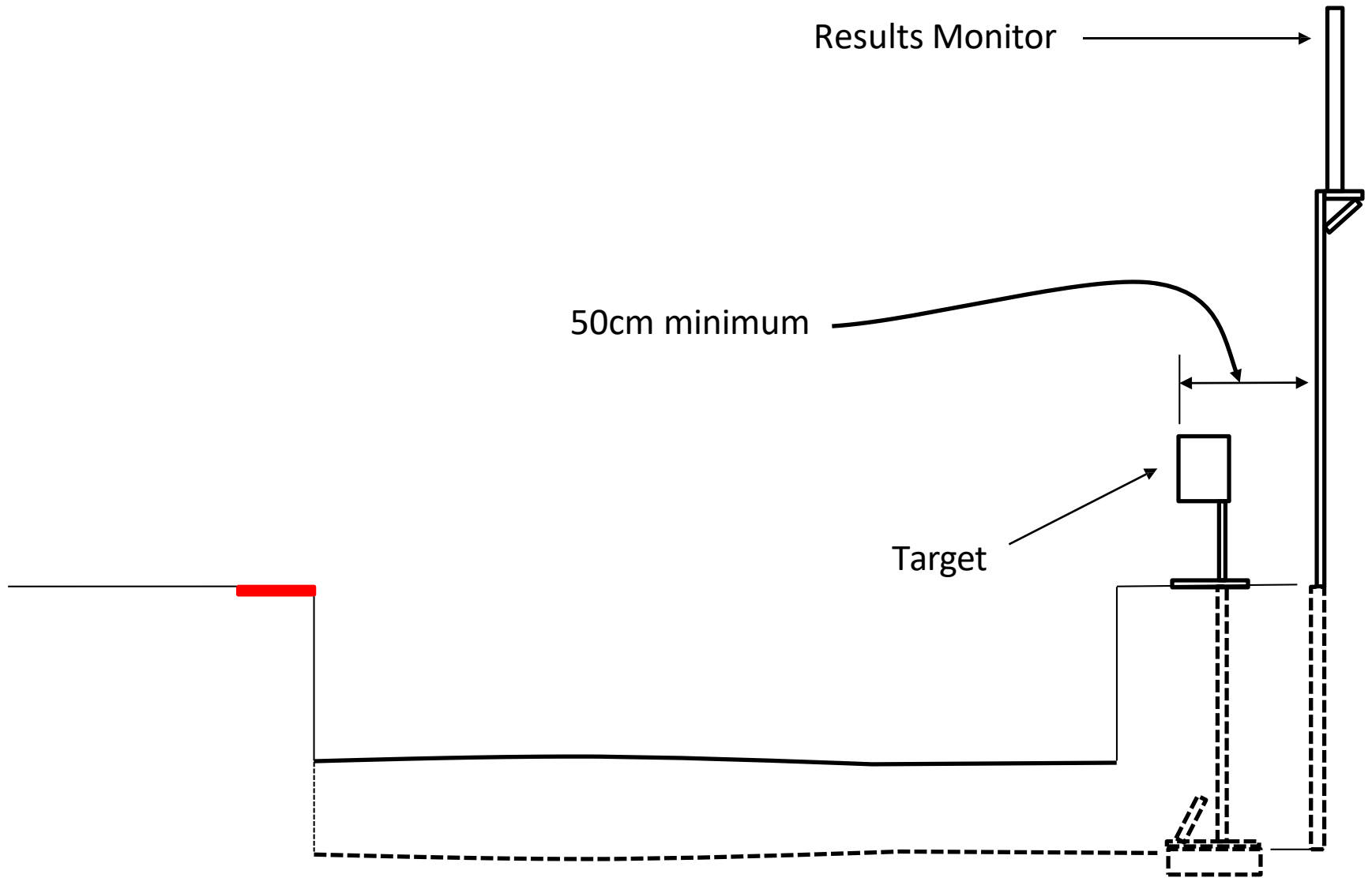

Alternate Target and Area for PWG
Requires Approval by FIS

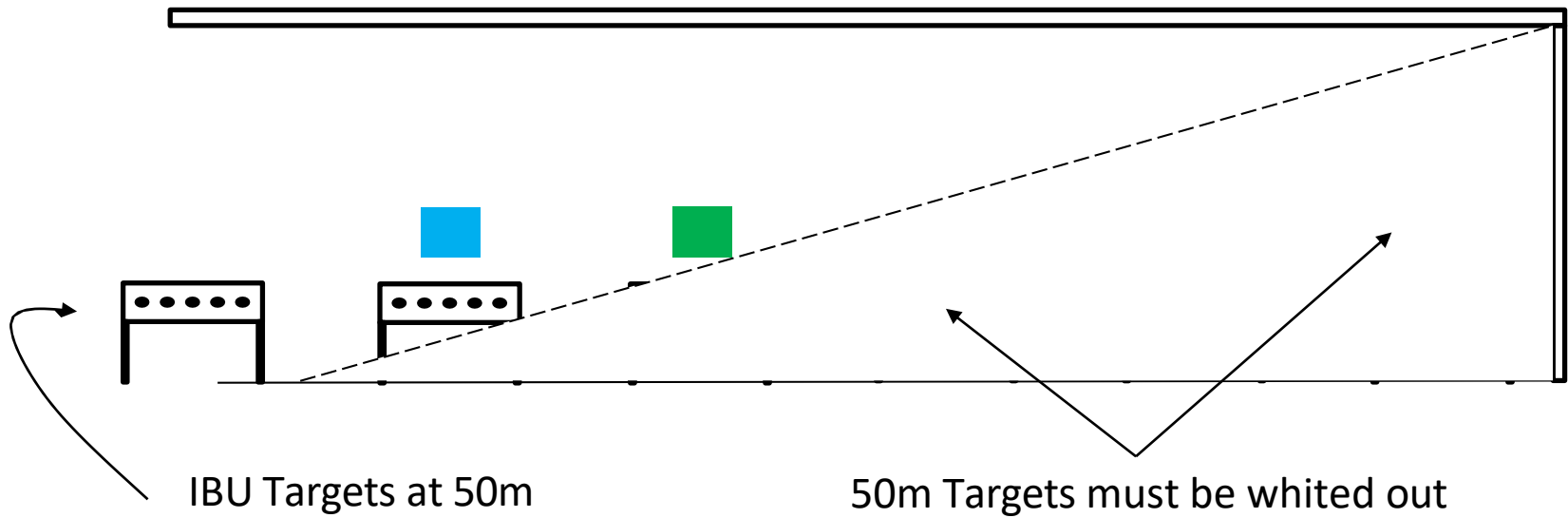

OR

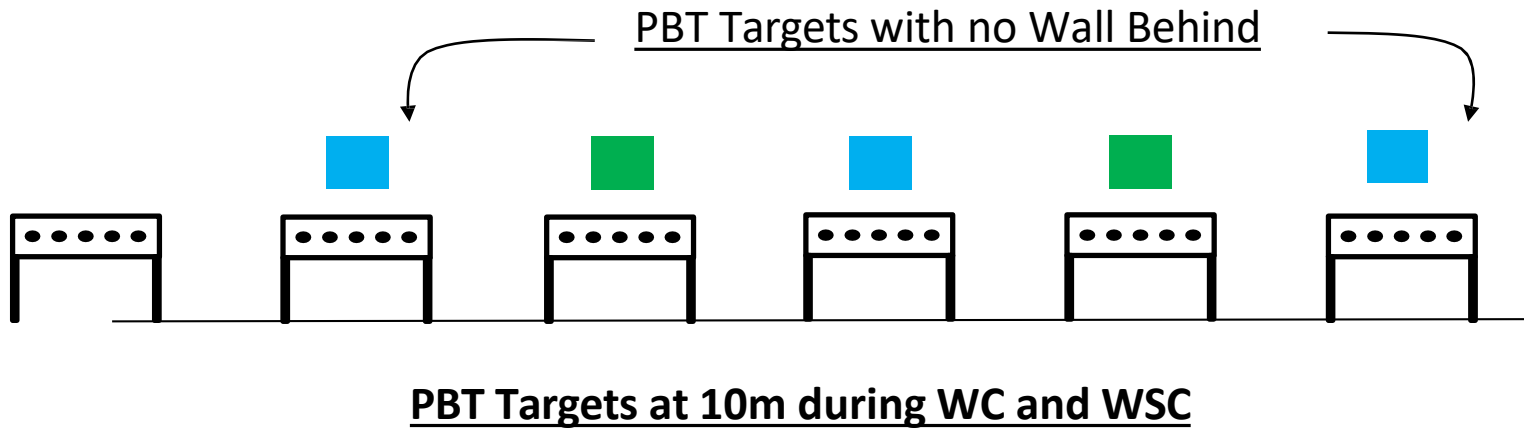

1 Display for each 4 Targets (or less)

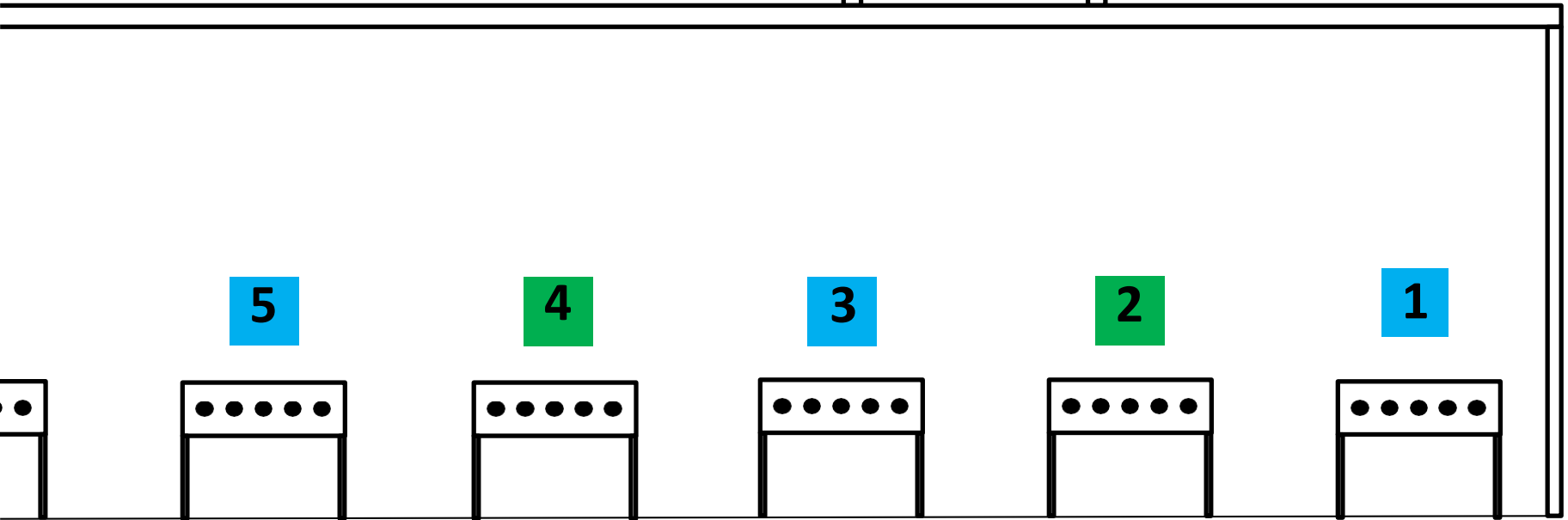
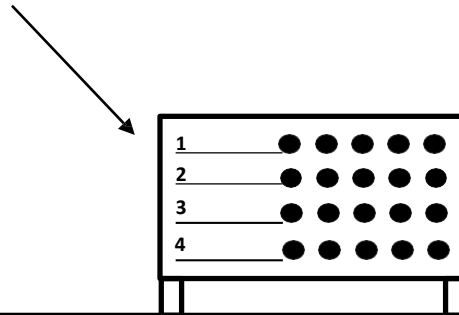

Monitors required for PWG

Penalty Loop

Penalty Loop Location

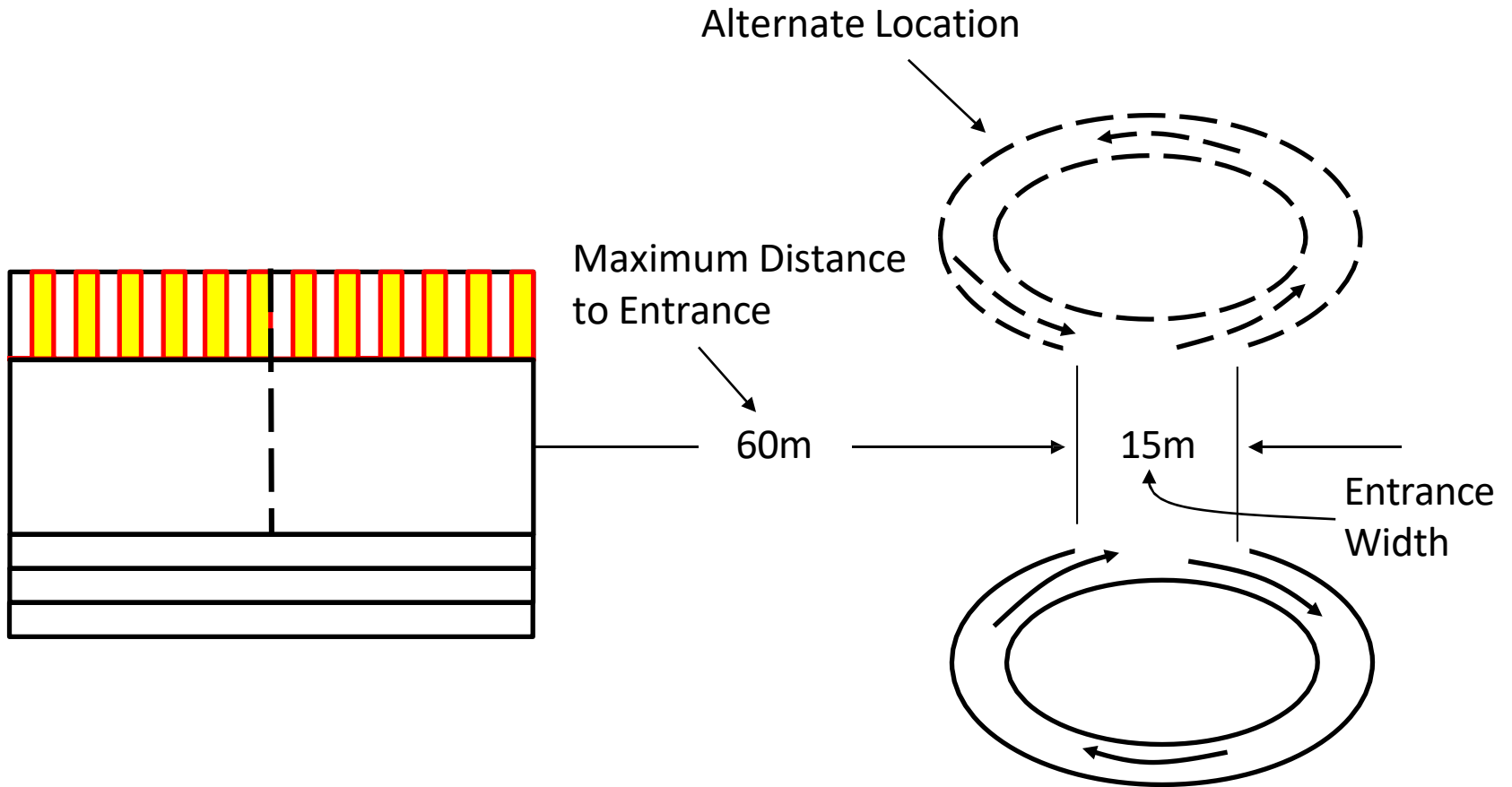

Art. 12332.2

Penalty Loop Distance

Distance – 80m, 100m or 150m
depending on race, measured on
inside loop.

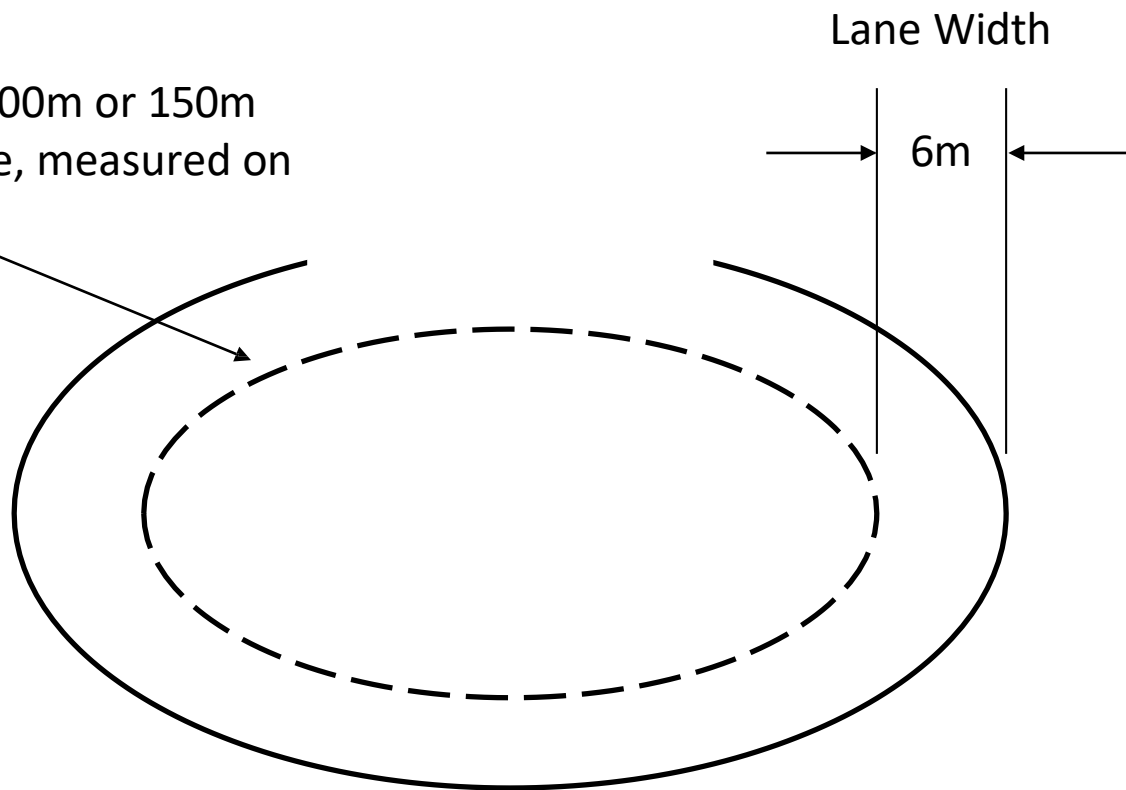

Art. 12332.2

Approximate Penalty Loop Area Required

150m Penalty Loop

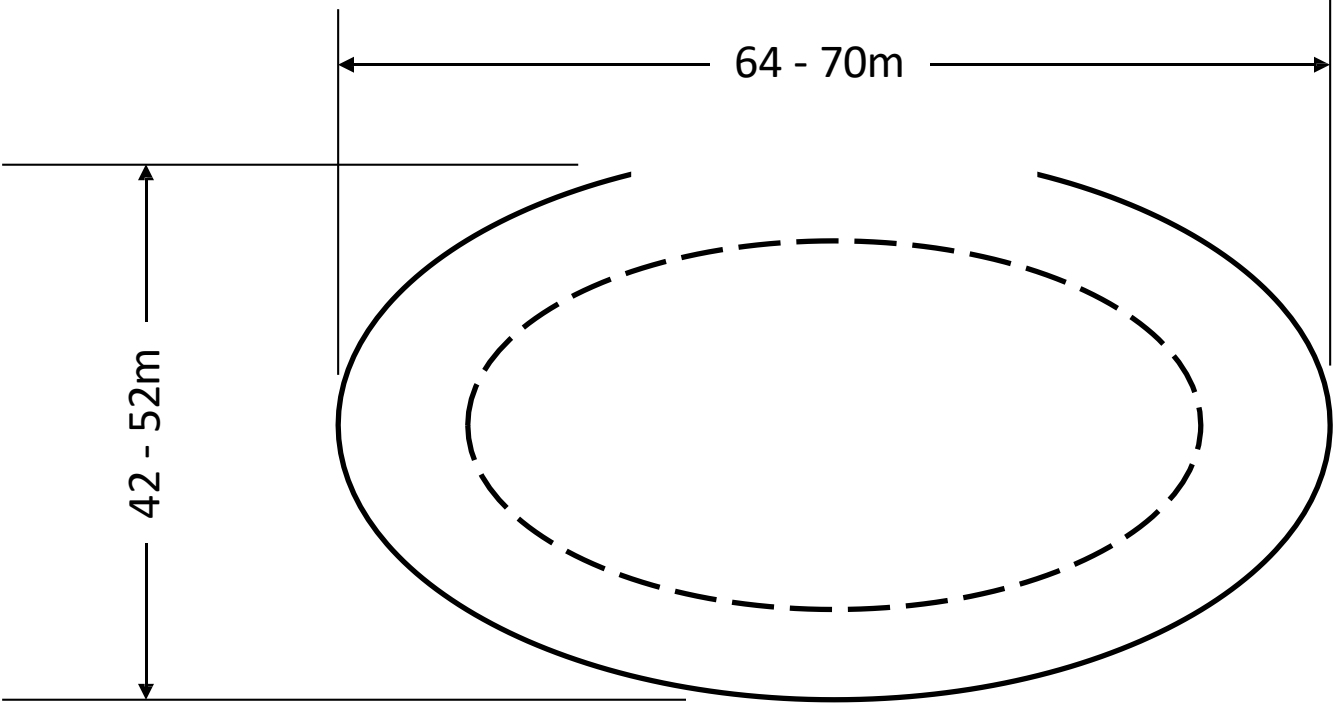

Lane Signage

Alternating, Contrasting Colors

(Color scheme shown below for illustration only)

Art. 12332.1.18

Lane Number Sign at Shooting Mat

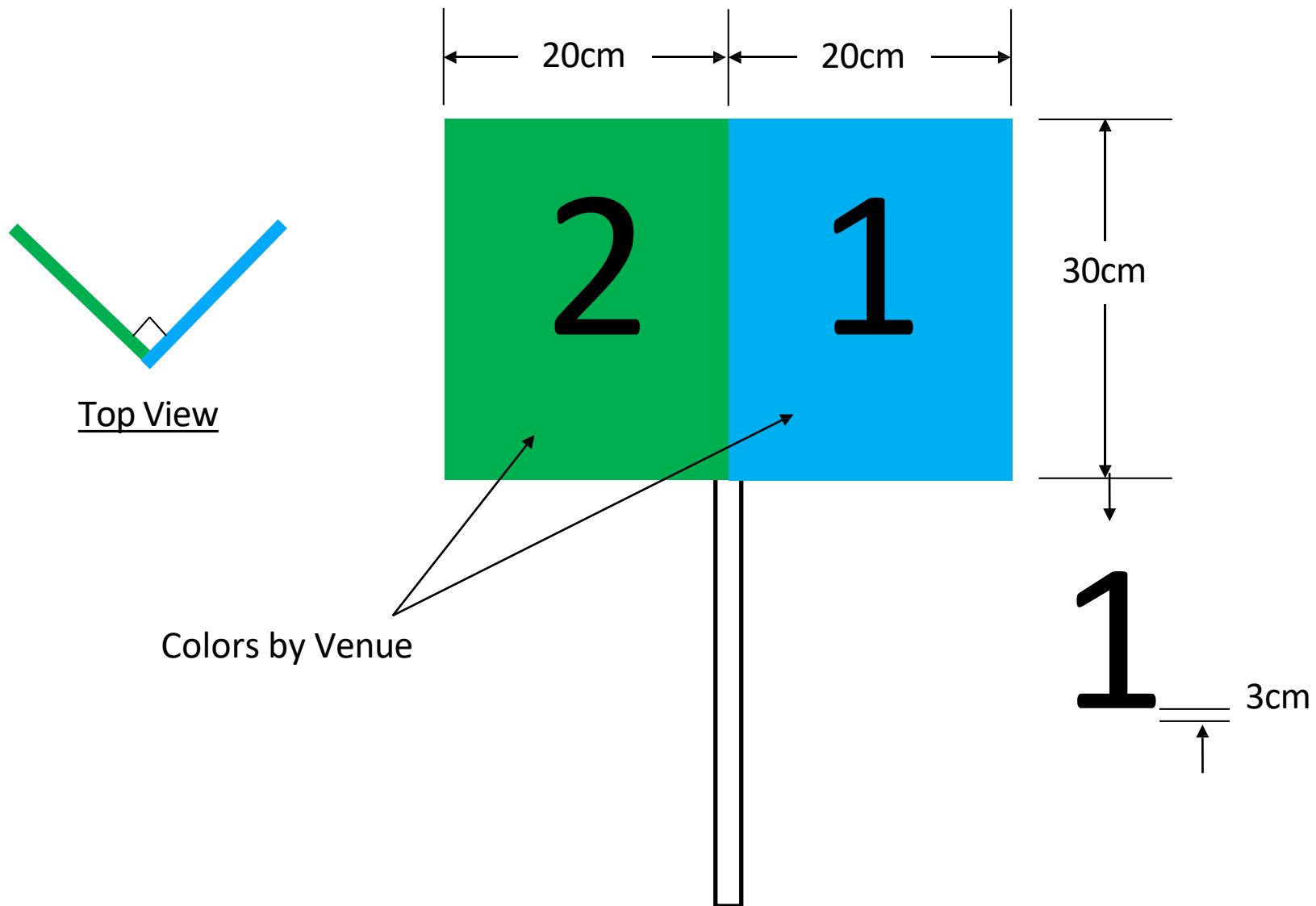

Art. 12332.1.18 Height of Lane Number Sign at Shooting Mat

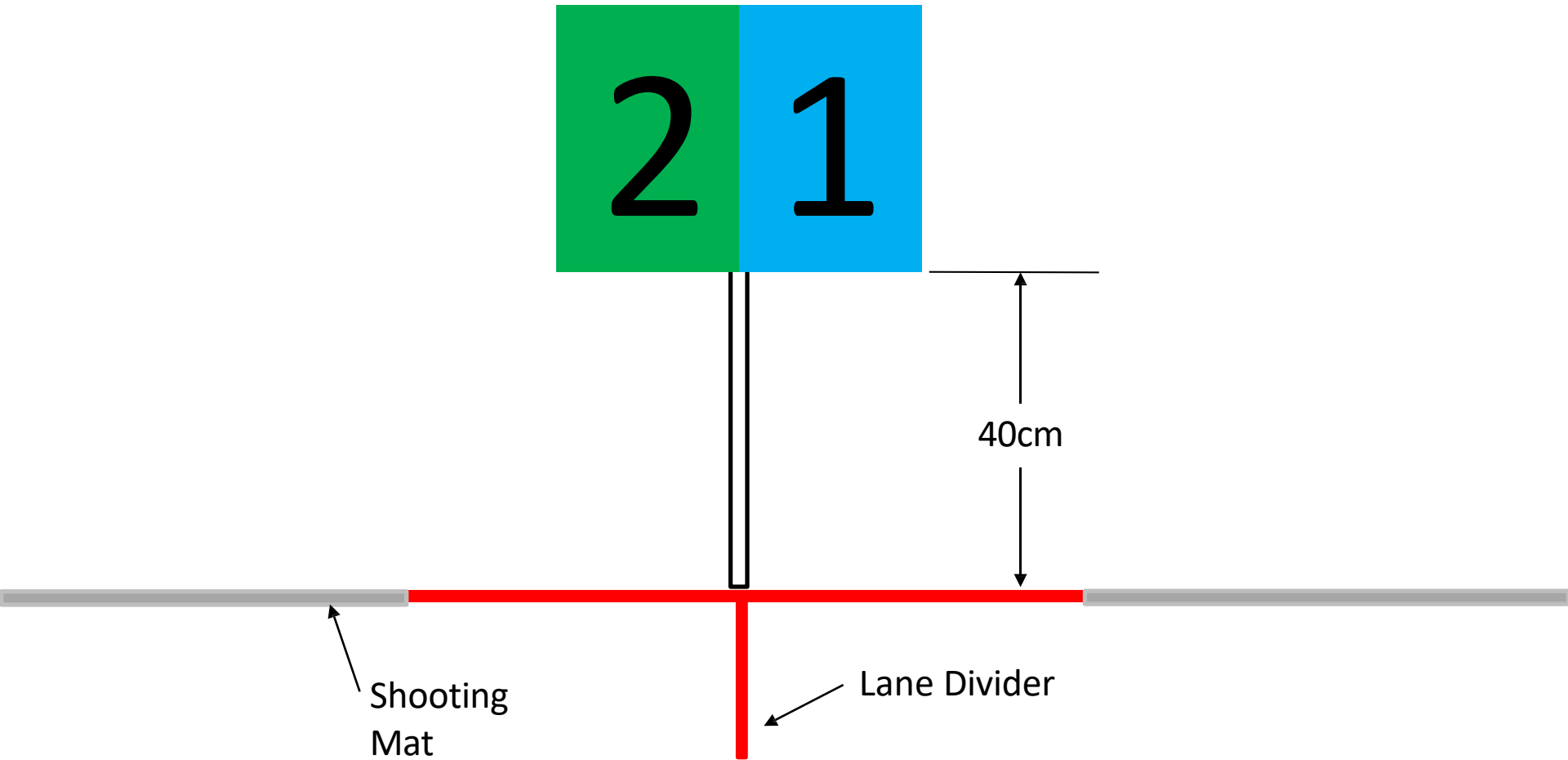

Art. 12332.1.18

Lane Number Sign at Shooting Mat

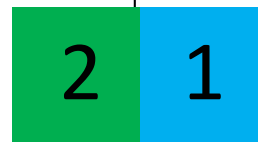
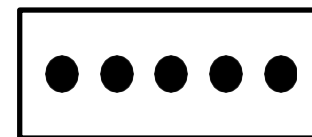
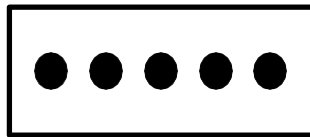
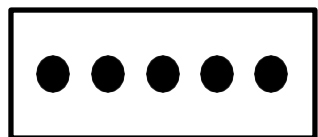

Art. 12332.1.18

Target Number Signs

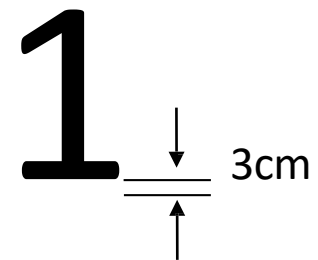
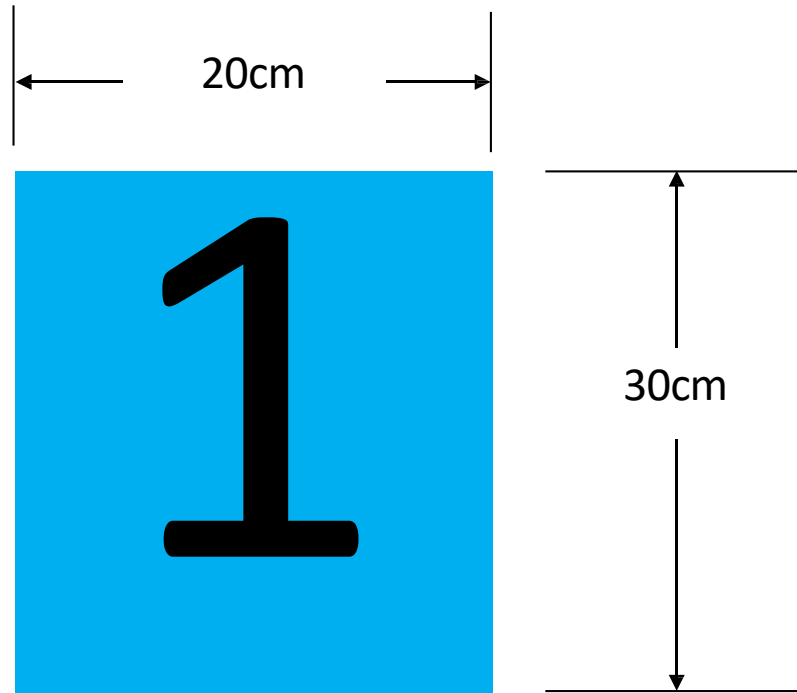

Art. 12332.1.18

Target Number Sign

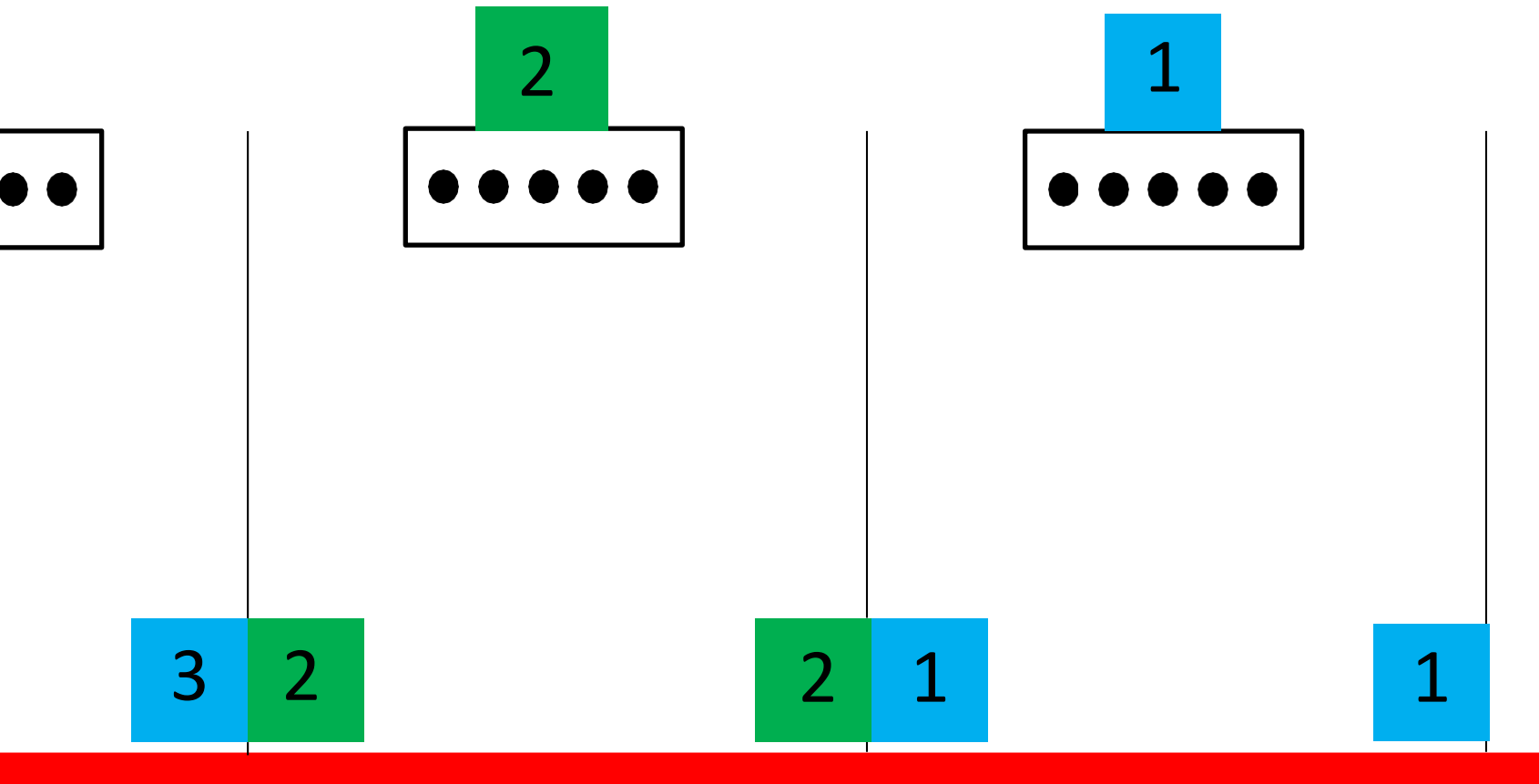

Art. 12332.1.18

Lane Colors at each Lane

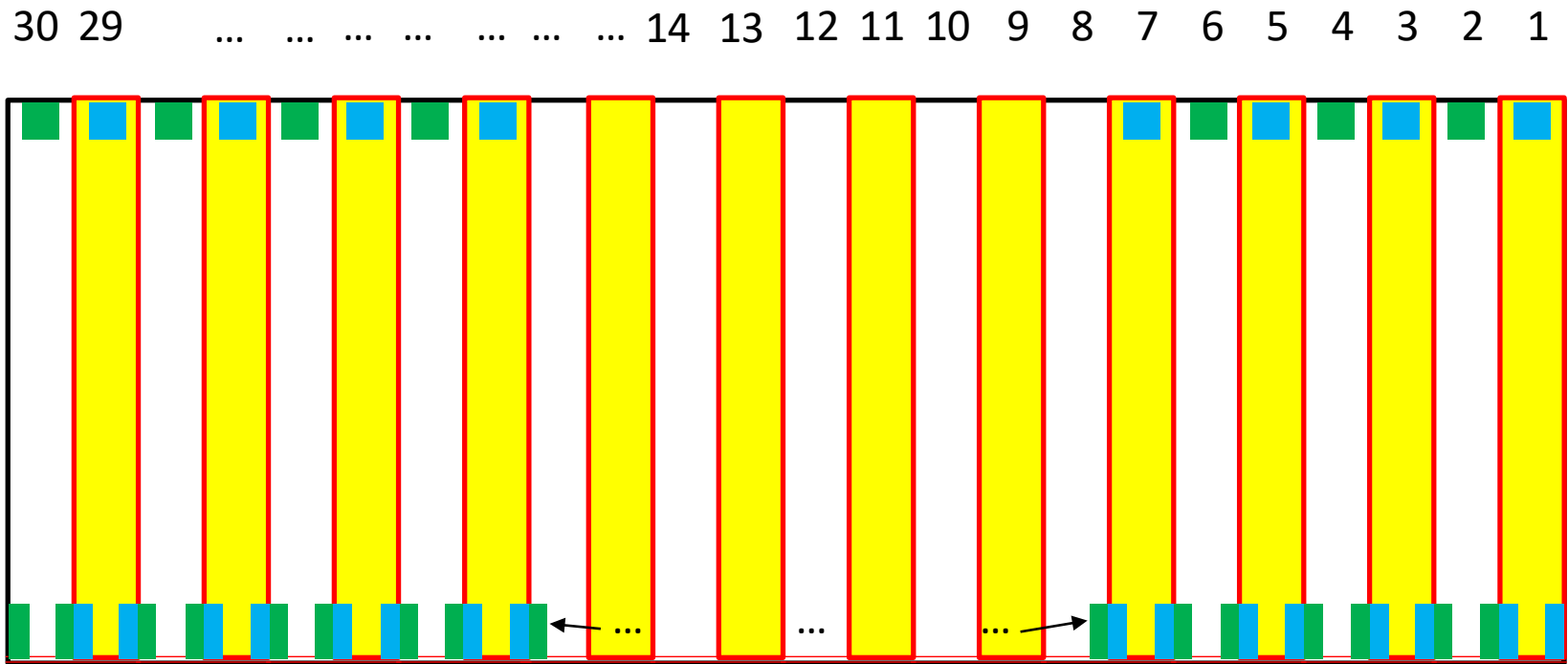

Art. 12332.1.18

T-Post Lane Divider Signs

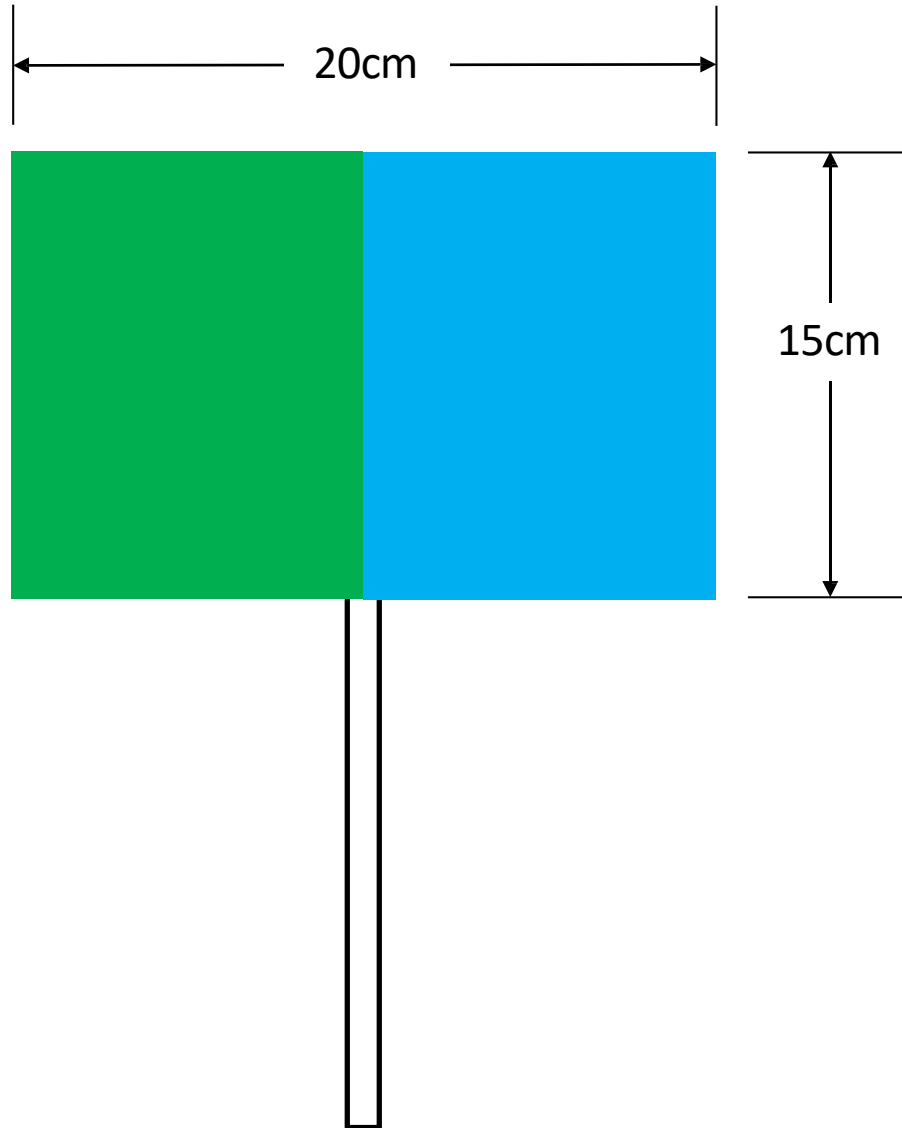

Maximum
Height

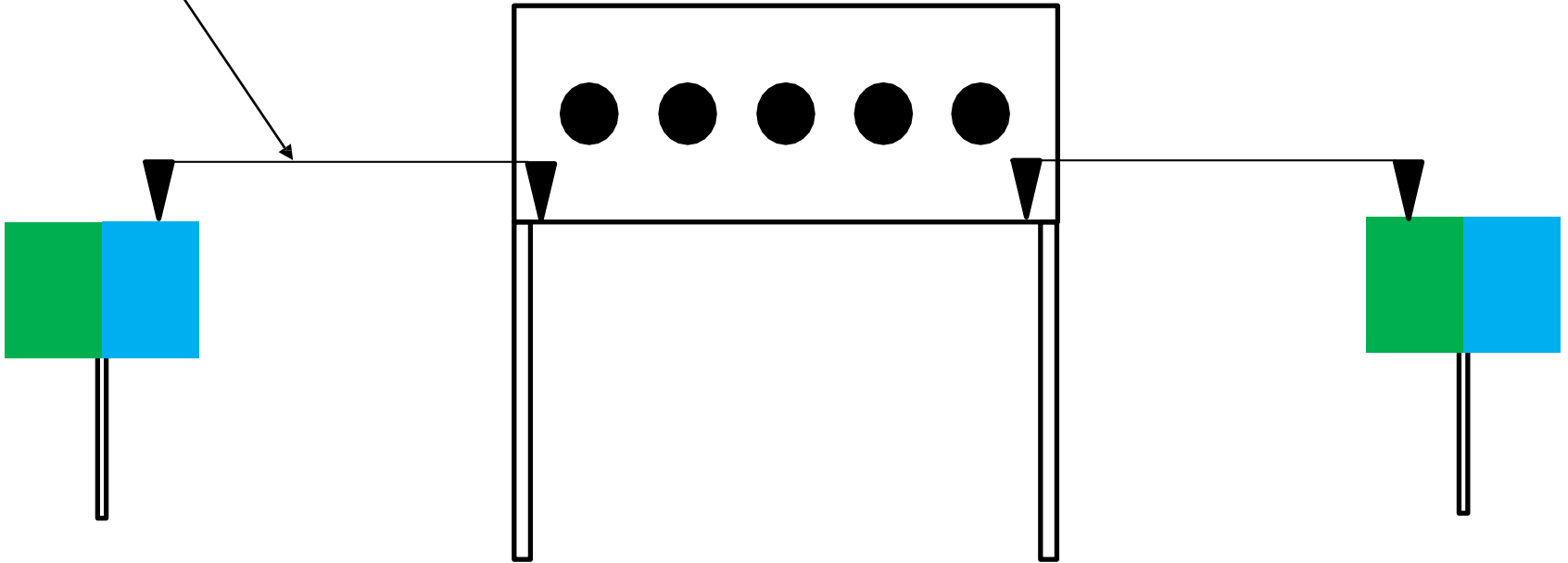

T-Post Height Placement

Art. 12332.1.18

T-Post Lane Divider Signs Position

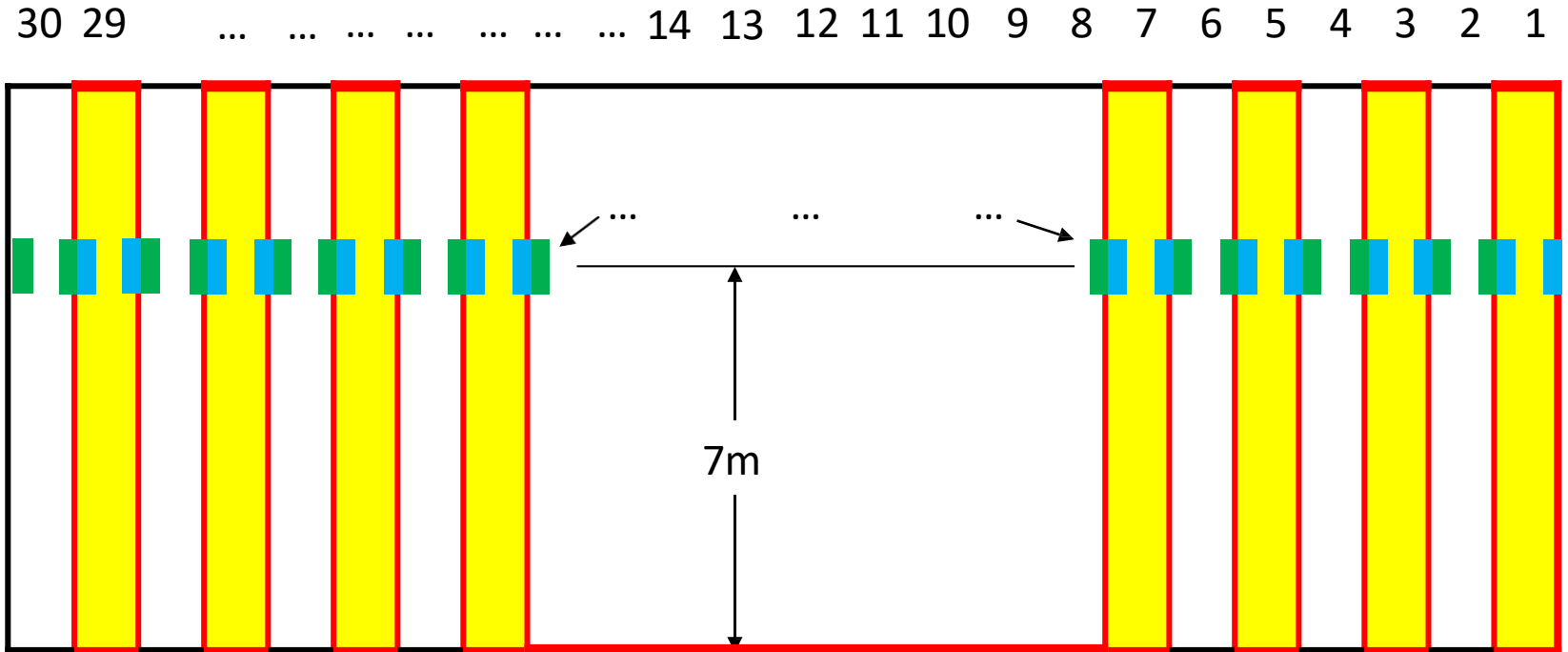

Wind Flags

Art. 12332.1.19

Wind Flag Position

LW - Shooting

B - Shooting

30 29 28 27 26 16 15 14 13 12 11 10 9 8 7 6 5 4 3 2 1

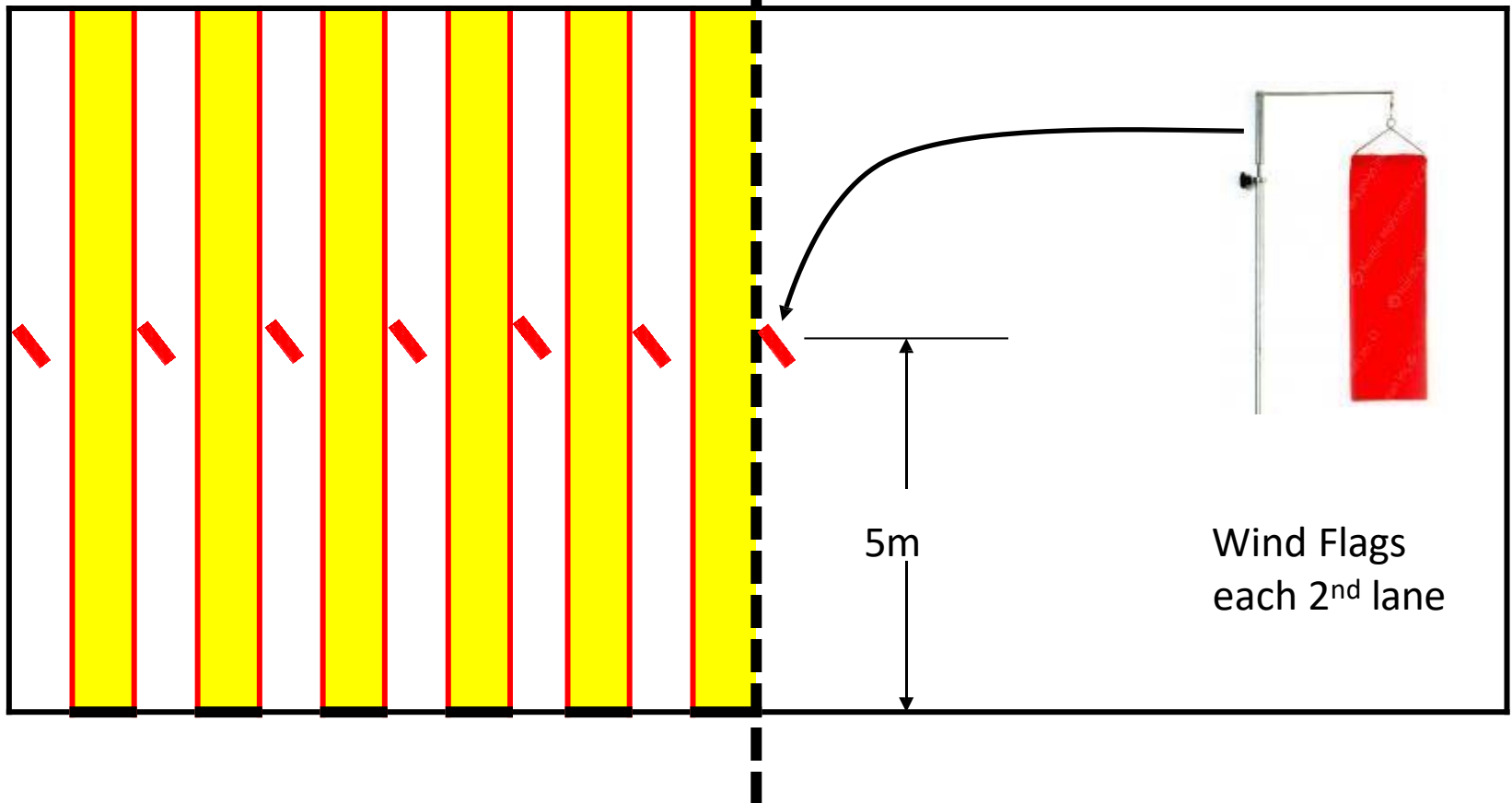

Art. 12332.1.19

Wind Flag Height Placement

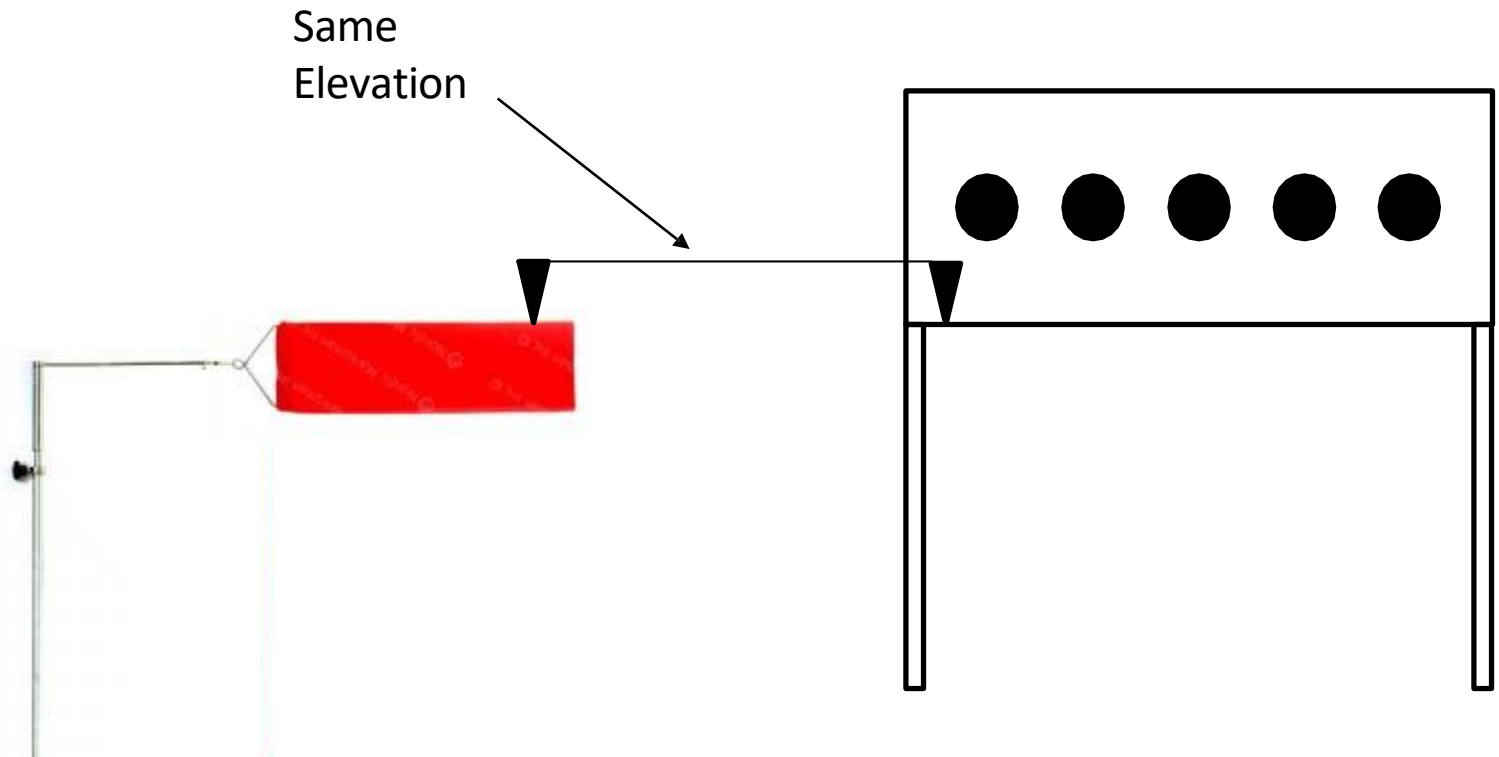

Firing Line & Equipment

Art. 12332.1.9

Lane Dividers

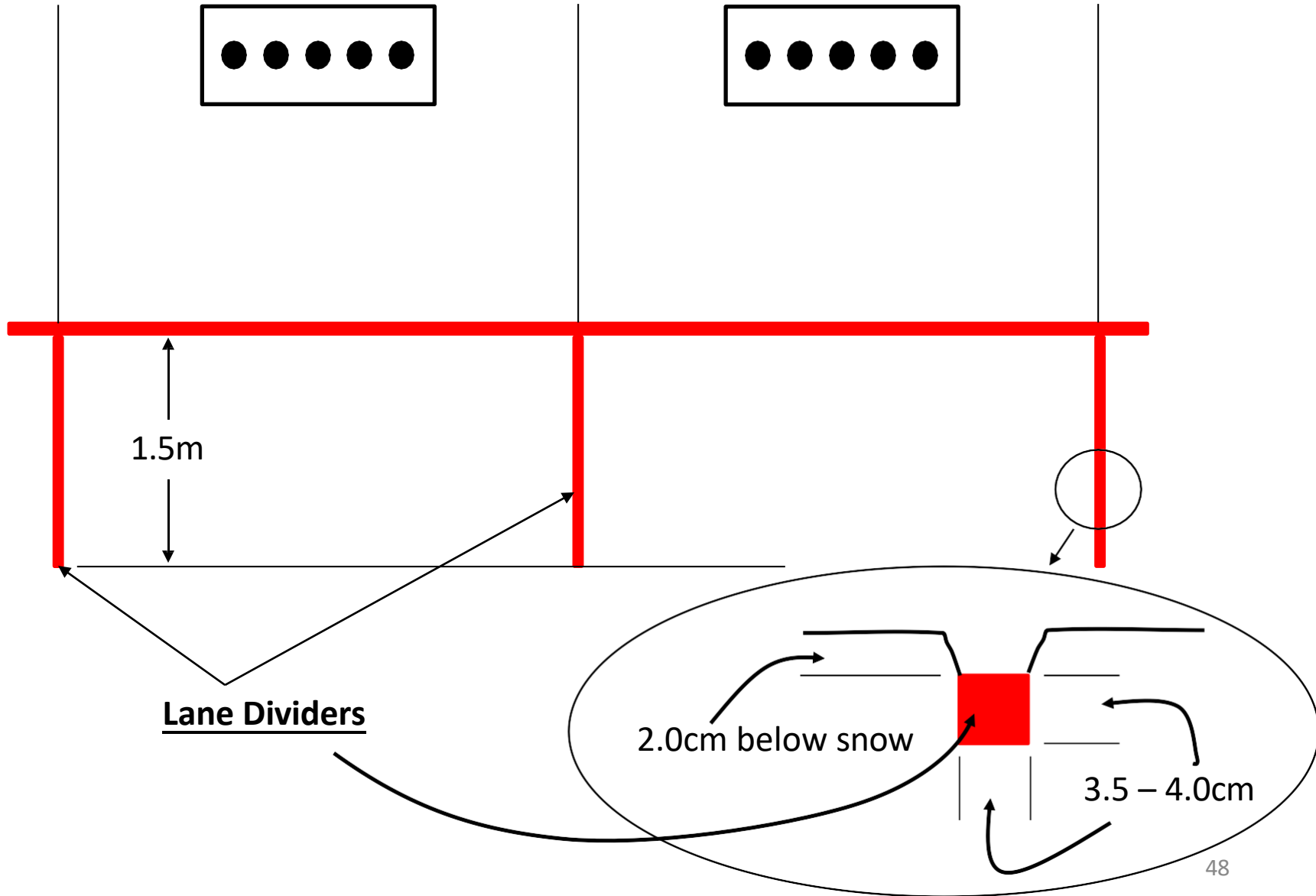

Lane Dividers

2.0cm below snow

3.5 - 4.0cm

Art. 12332.1.5

Firing Line

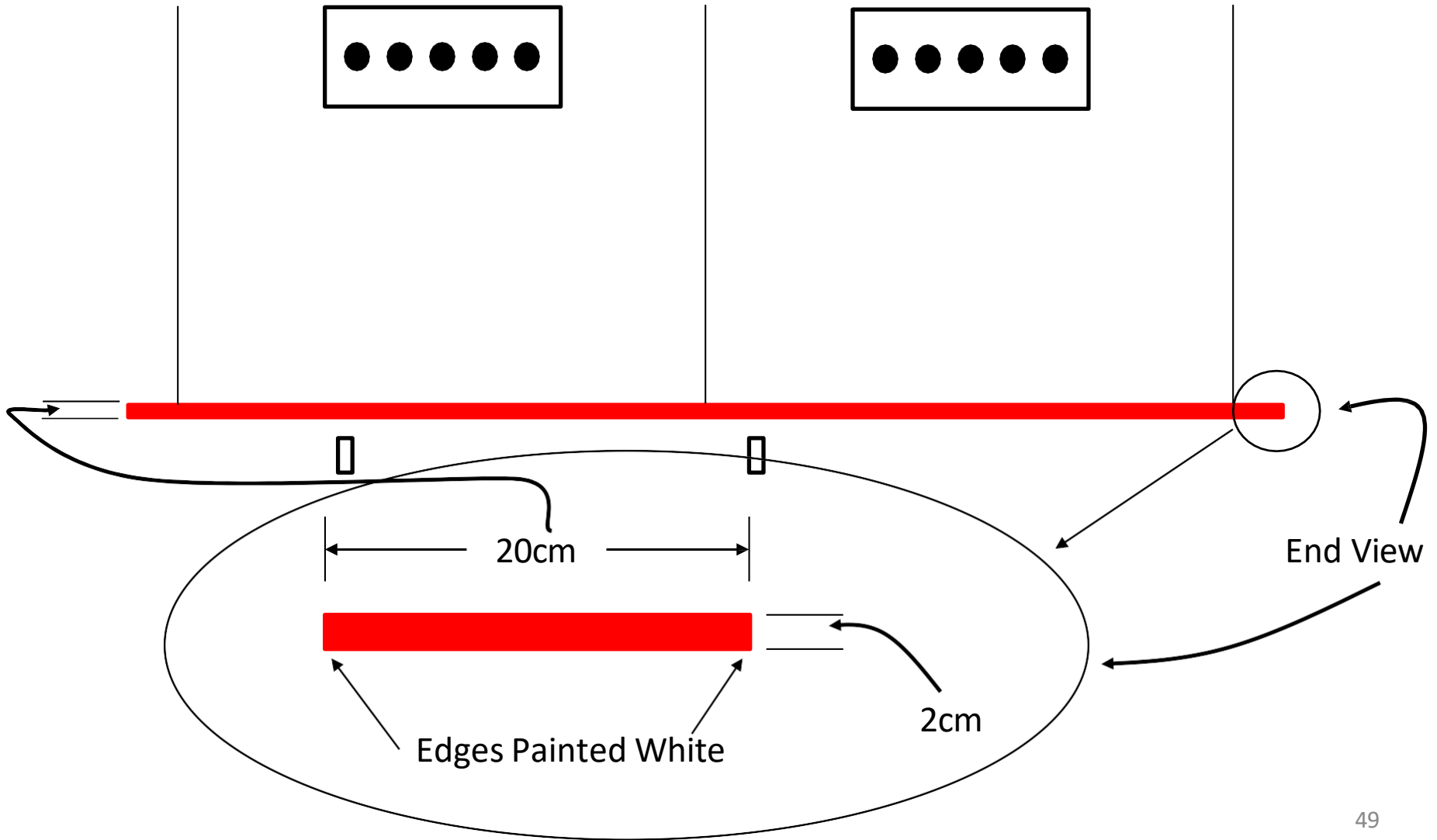

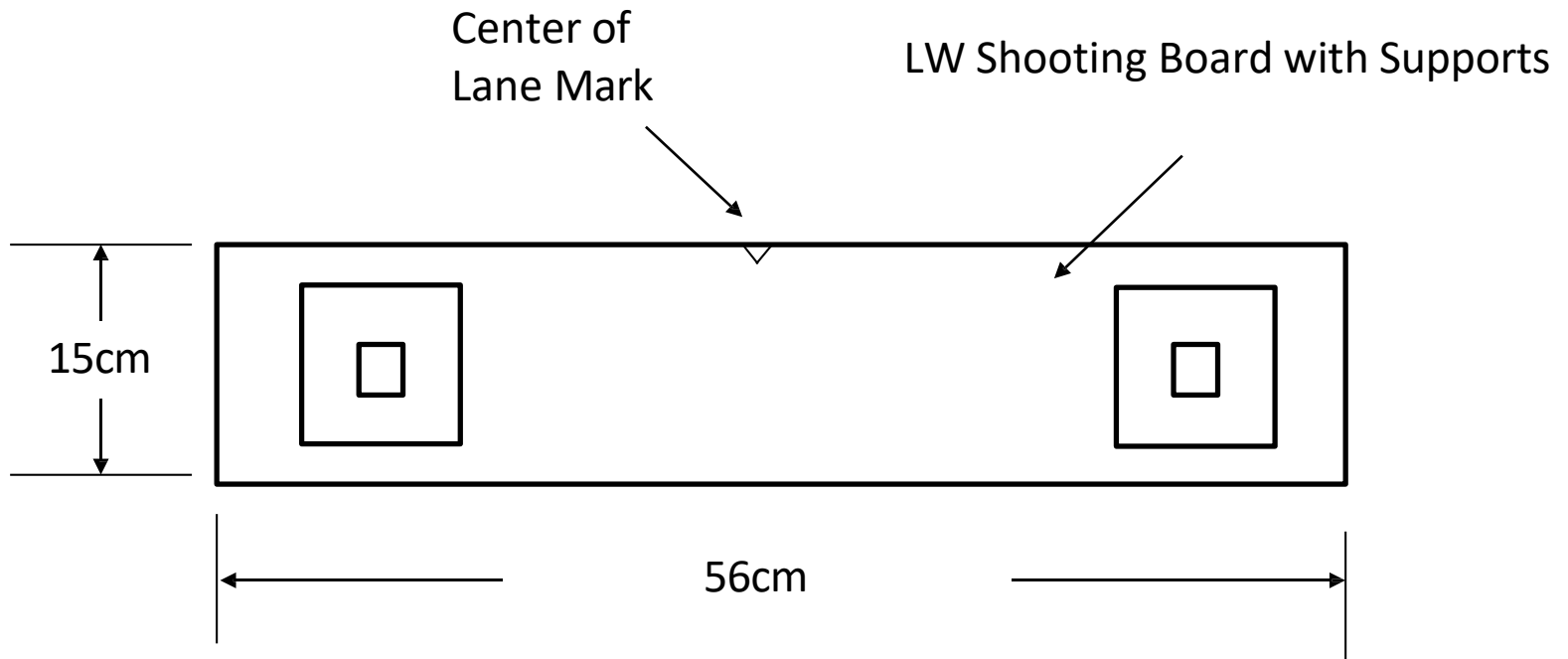

LW Shooting Board

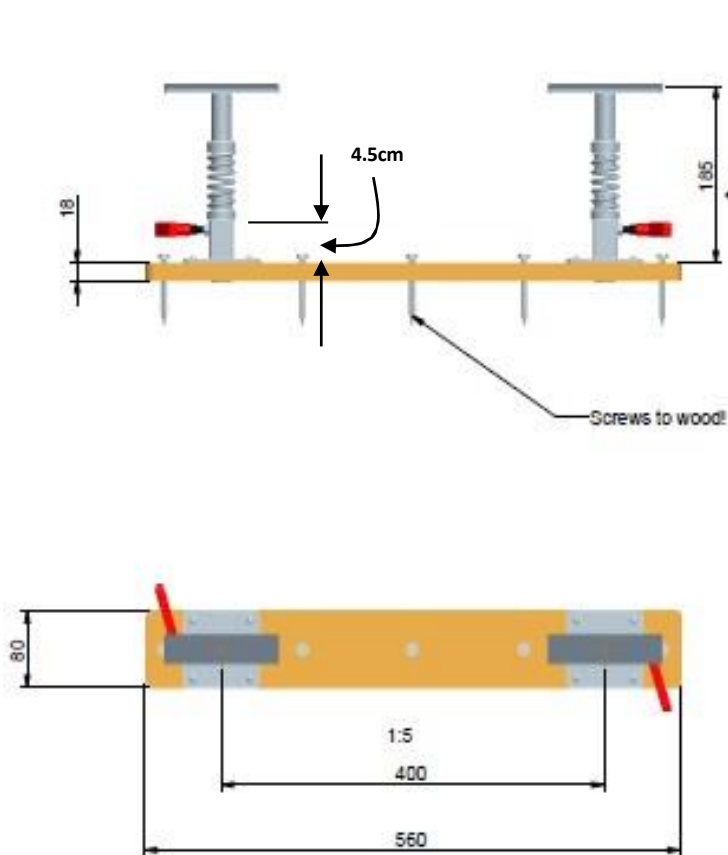

MIN HEIGHT, MAX HEIGHT is 235mm

4.5cm

18

185

Screws to wood!

80

1:5

400

560

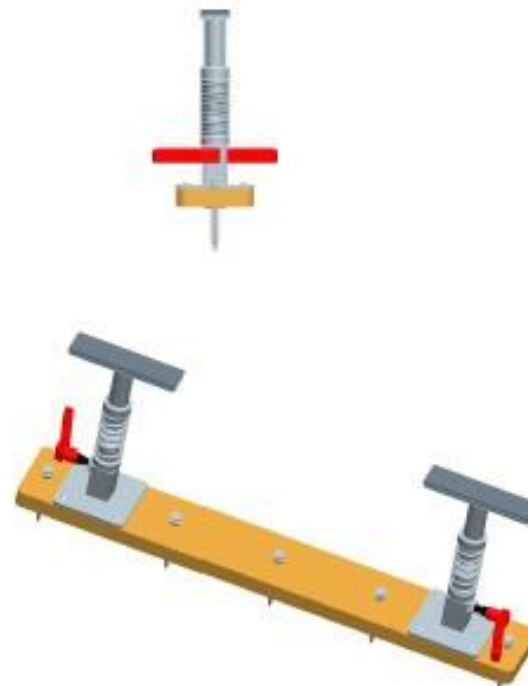

LW Shooting Board & Support Specifications

| | | | | | | | | | |
|--------------------------|-----------------|---------------|------------------|-----|-----------|------------------|---|--------|-----|
| 4 | PUURUWI | | | | | | | | 0 |
| 3 | LV+RUUVI_0_3X70 | | | | | | | | 0 |
| 2 | 900736C | | pohjavienit.prt | | | | | | 1 |
| 1 | 900639C | | LW-estuki_scoote | | | | | | 2 |
| Des | loodi | | Nimitye | | | | Muudato | | Wpi |
| Pilt | MAK | Tuote nimi | 110810 | Pvm | 11-Aug-10 | Tiedosto | D:\prose_work\eko-aiwa\hakeva\materiaal\LW-tuki | | |
| Suomen Biathlon Oy | | Nimi | Eko-Aims | | Tuote | LW-tuki | | Muoto | - |
| | | Koodi | B00734C | | Ver | tuot_levylla.asm | | Pilaus | |

LW Shooting Board in Center of each Lane

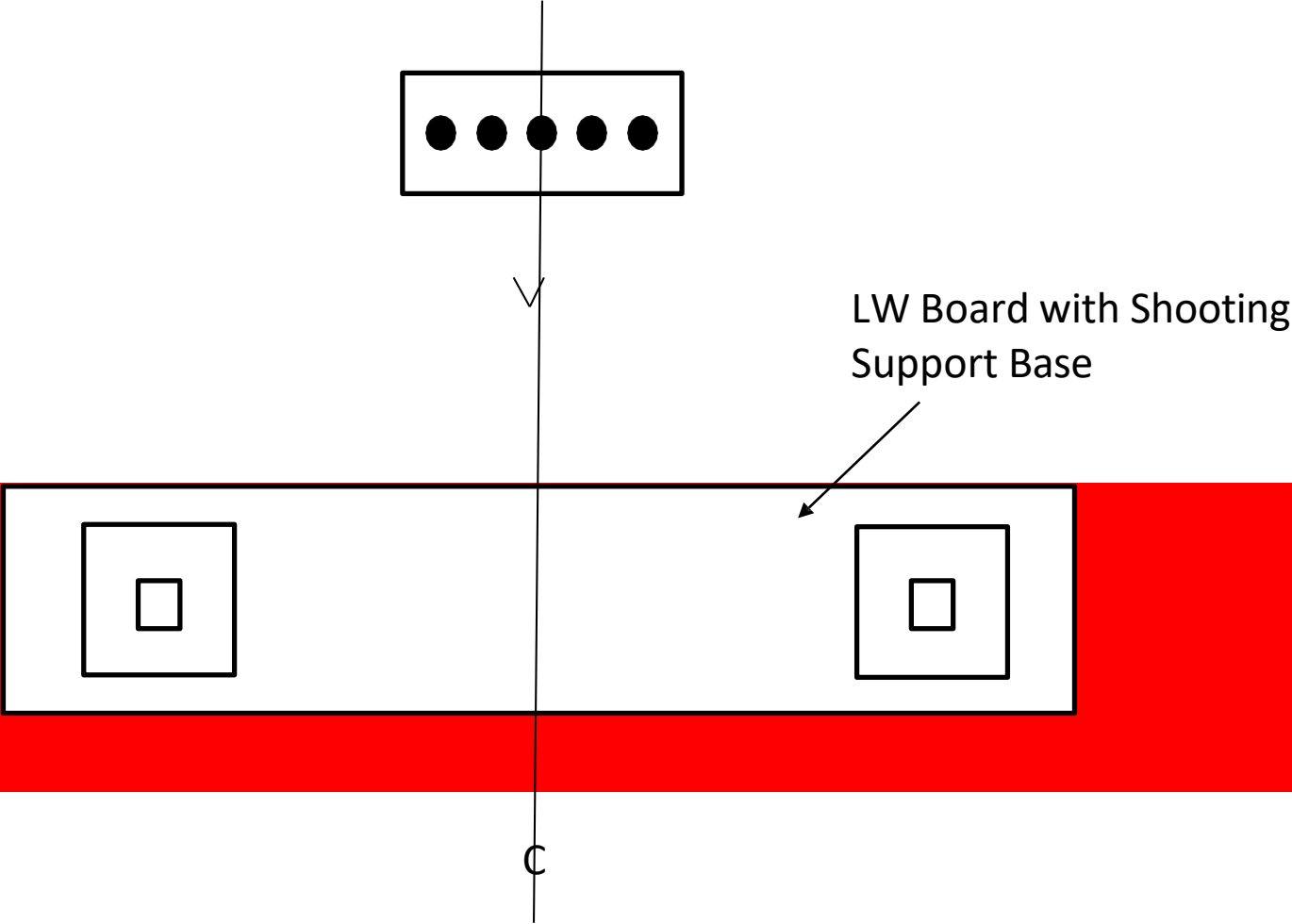

Board & Target Centered

B Shooting Board

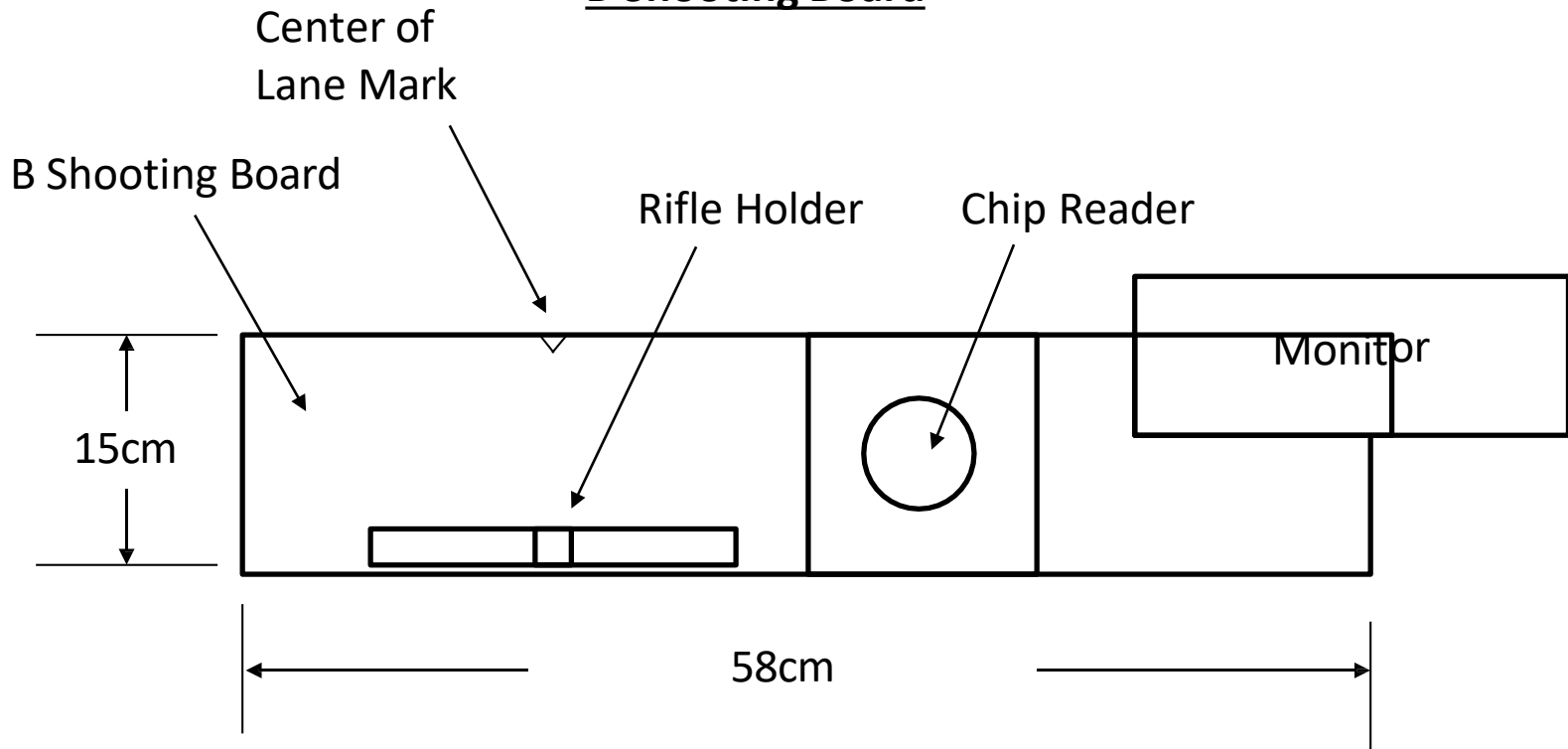

Top View

Chip Readers and Chips

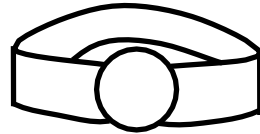

Athlete Identification
and Reset Chip



Chip Reader

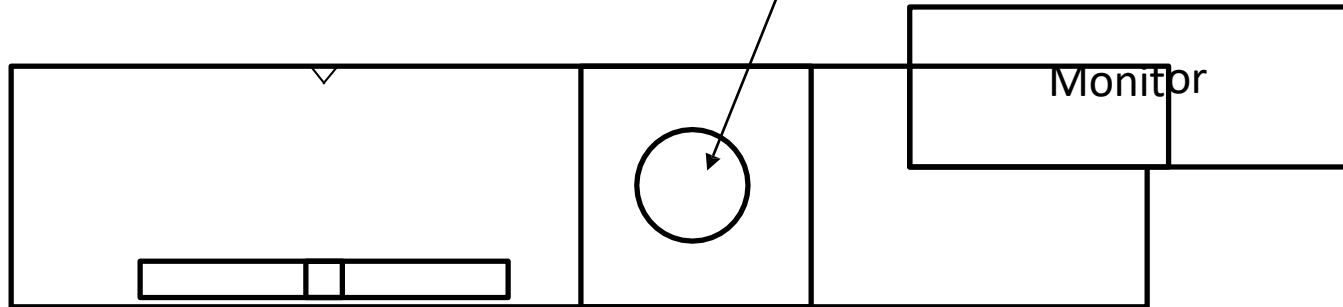
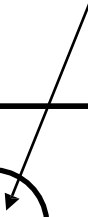

Top View

B Shooting Board & Equipment Specifications

EBSS-assembly in use

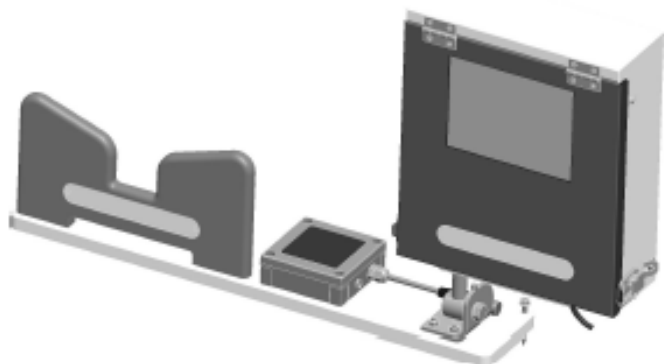
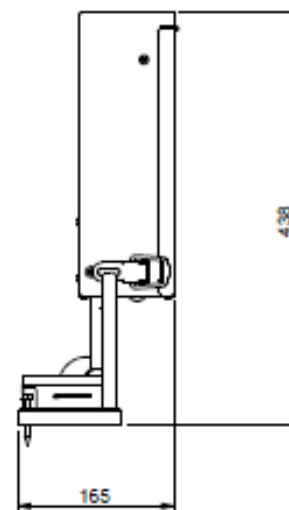
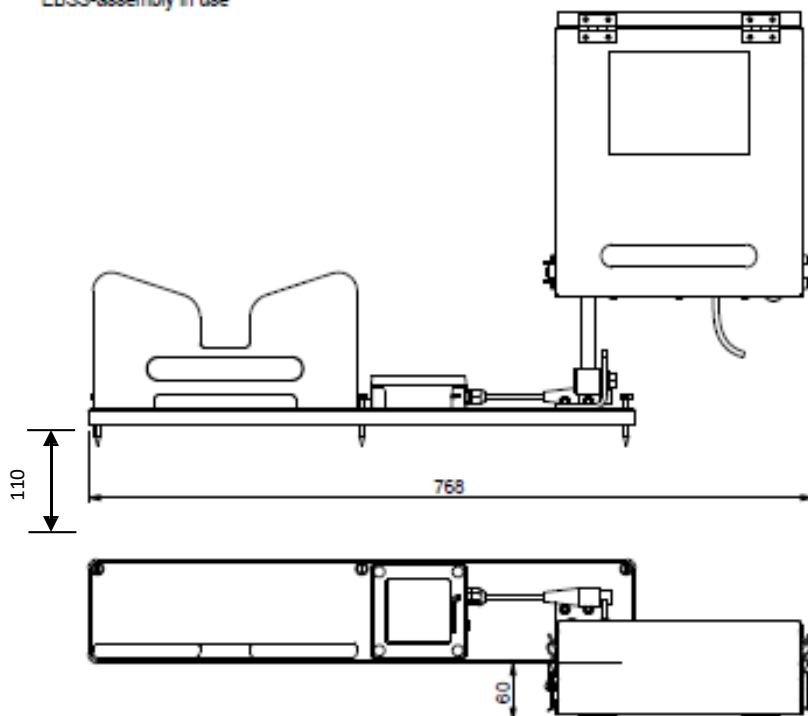

| | | | | | | | |
|--------------------------|------------------|---------------------------------------|--------------|-------|-------------------------|-----------|---|
| 14 | LVI-RUUVI_6_3x50 | | | | | 7 | |
| 13 | E00690A | Aestuen runkolevy | | | | 1 | |
| 12 | E00373A | Eco-aihe-lama, uusi logo, vanha musta | | | | 1 | |
| 11 | E00337B | S-DK näyttö ja kotelo | | | | 2 | |
| 10 | E00329B | Pöytävarsi | | | | 1 | |
| 9 | E00326A | pyöryväsi kanta | | | | 1 | |
| 8 | E00323B | Pöytälevy | | | Pöytäliikkuus/kiinnitys | 1 | |
| 7 | E00275D | RFID-tuki | | | | 1 | |
| 6 | E00119A | lykkäusku kiinnin | | | | 1 | |
| 5 | DIN909M6 | | | | | 4 | |
| 4 | DIN901M6X25 | | | | | 4 | |
| 3 | DIN901M10X25 | | | | | 1 | |
| 2 | DIN125A_M6 | | | | | 4 | |
| 1 | DIN125A_M10 | | | | | 1 | |
| Osa | Ruuti | Nimitys | Muutos | | | Kpl | |
| Pit. | EK | Tuotteen ajona | 27.12.2016 | Pvm | 05-Jun-18 | Tiedosto | Z:\Pro_E_Vanha\Pro_Work\WF\Eco-aihe\Valokuvat\asetus\Uusi\asetus12012 |
| Suomen Biathlon Oy | | Yhteisö | Ekko-Alms Oy | Tuote | EBSS-kokoonpano | Massa | 187,18889.280 kg |
| | | Koodi | E00369A | Ker | Yhteisö | Pöytälevy | 65 |
| | | | | | EBSS-tuki koteloilla | | |

B Shooting Board Position in each Lane

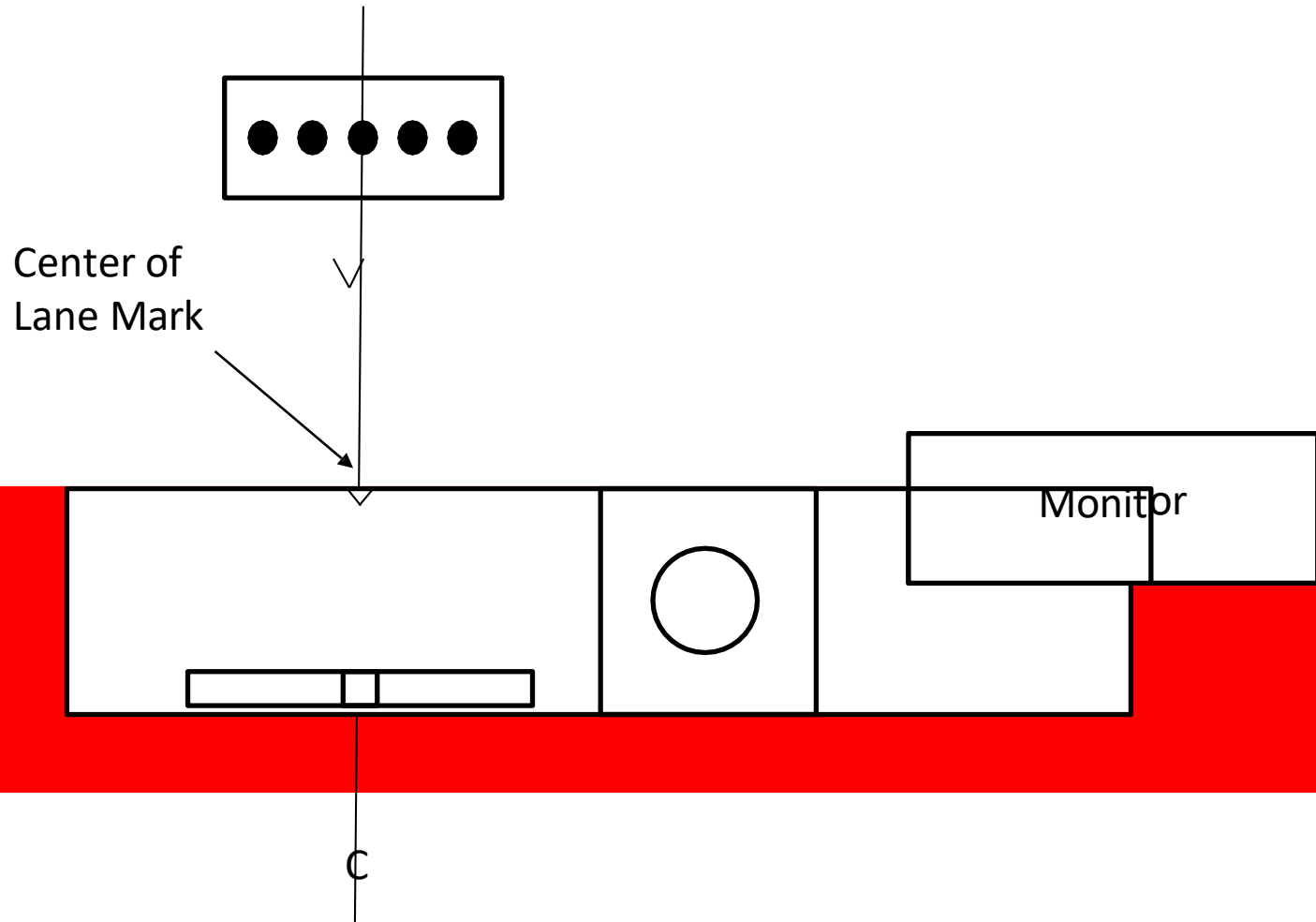

Rifle Holder & Target Centered

Monitor Position in each Lane

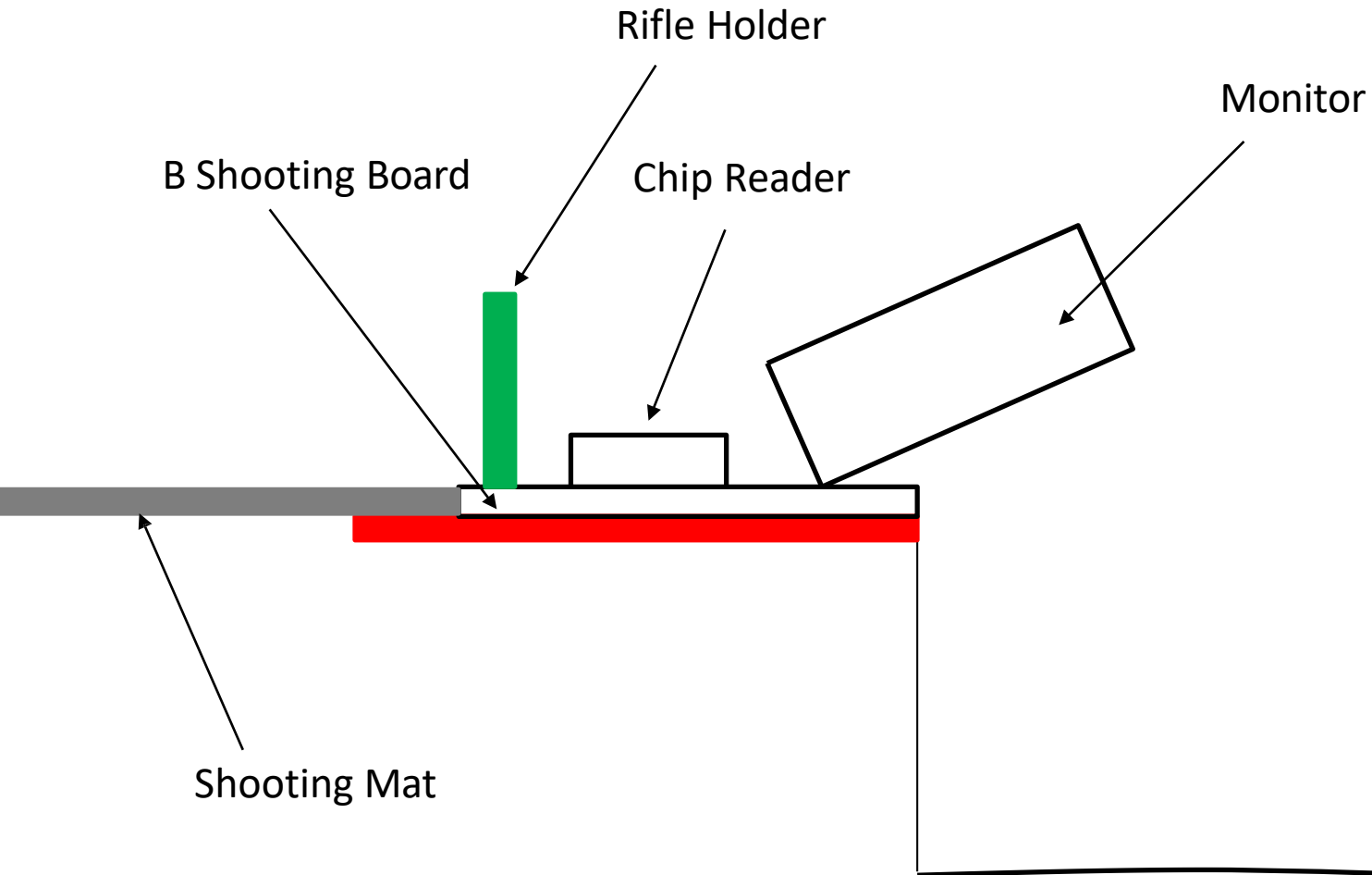

Art. 12332.1.10

Shooting Mat Attachment

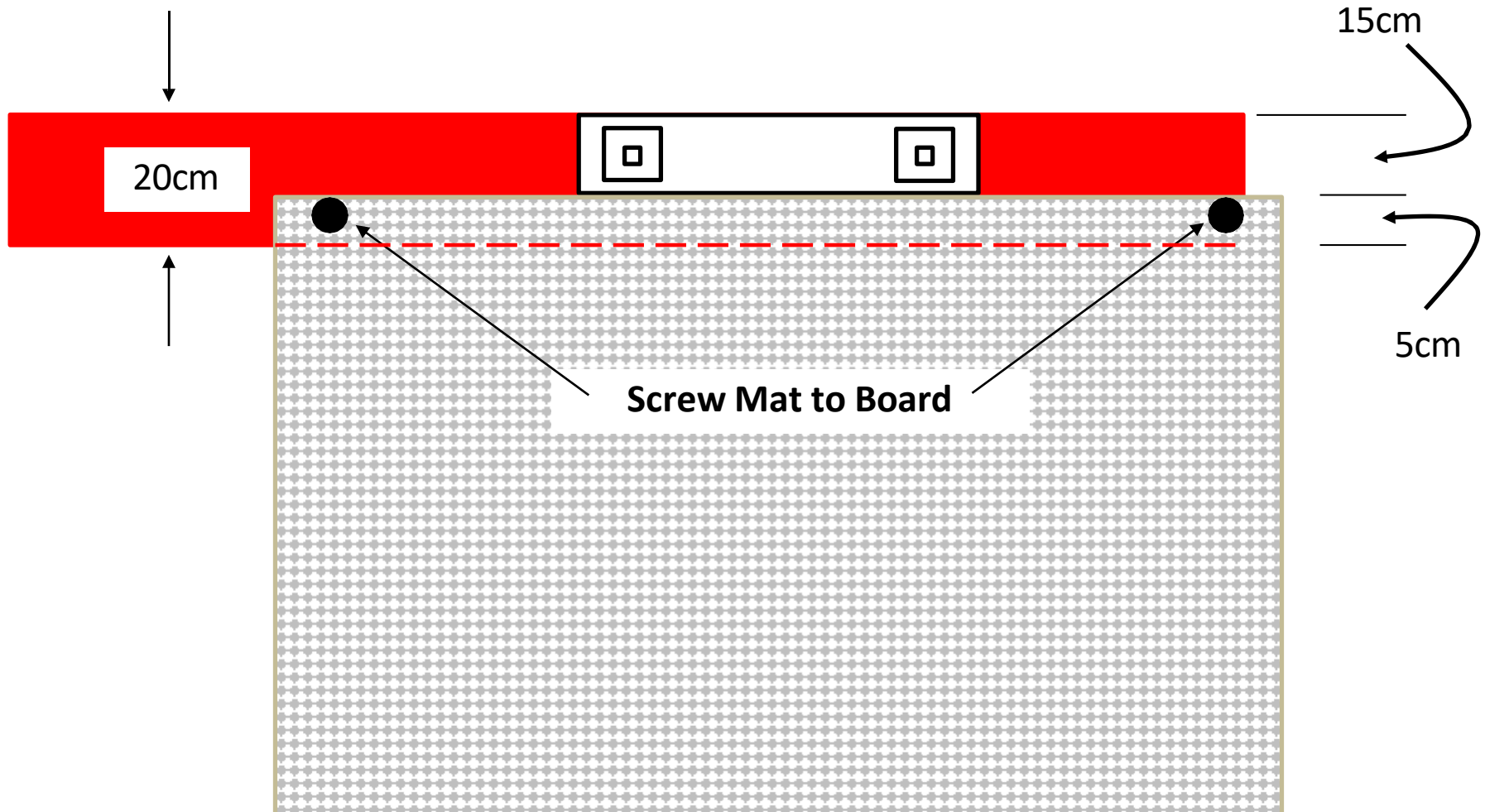

Other Equipment

All PBT Events

Time of Day Clock
Required



Positioned
between LW and B
shooting lanes

LW - Shooting

B - Shooting

... .. 9 8 7 6 5 4 3 2 1

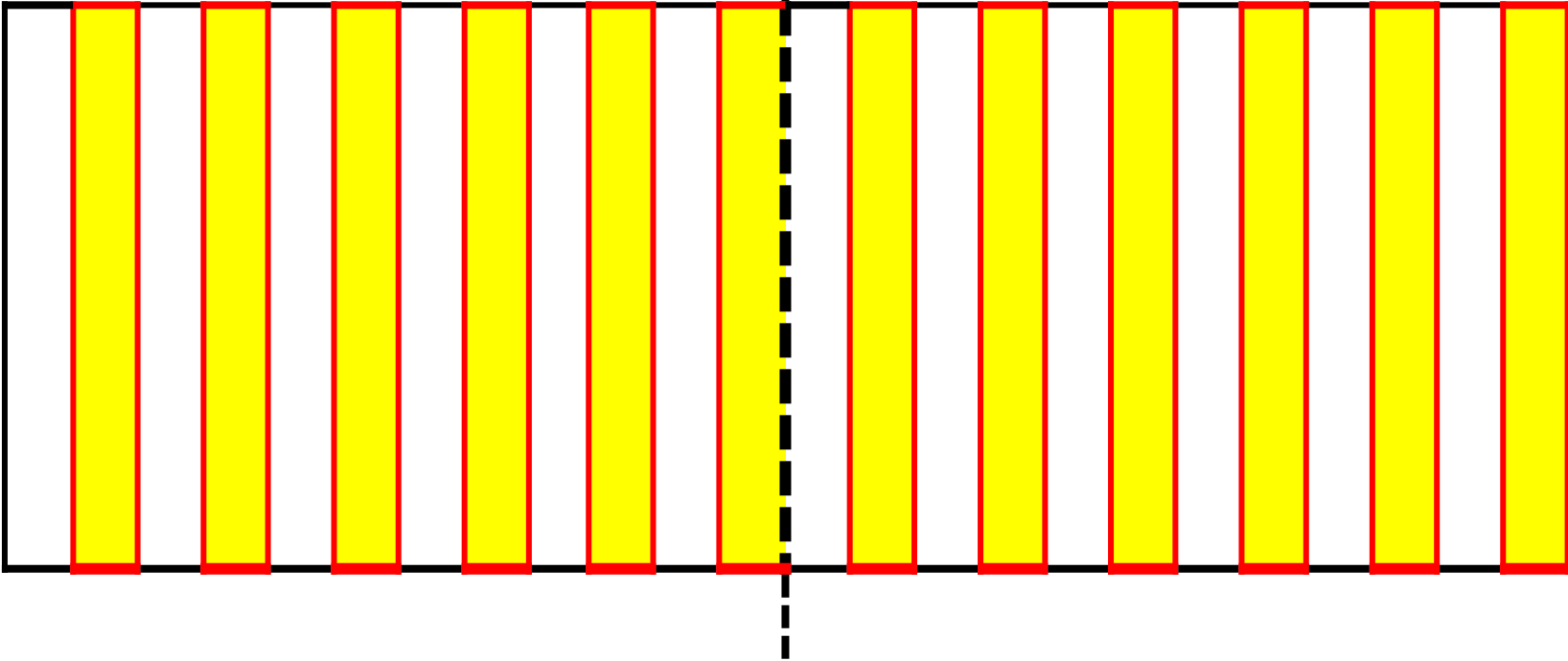

Electrical Outlet for Clock and Targets as required

LW - Shooting

B - Shooting

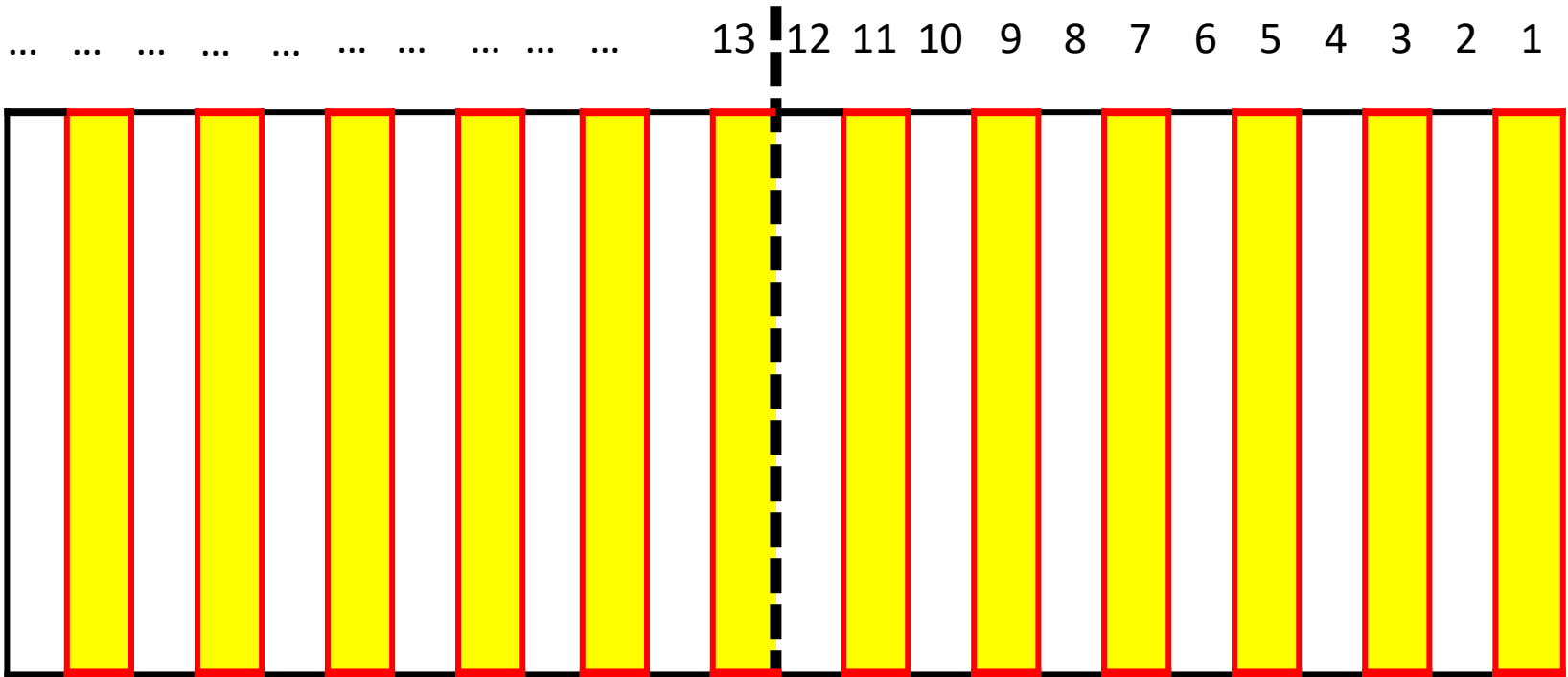

Rifle Racks and Coaches for Air Rifle

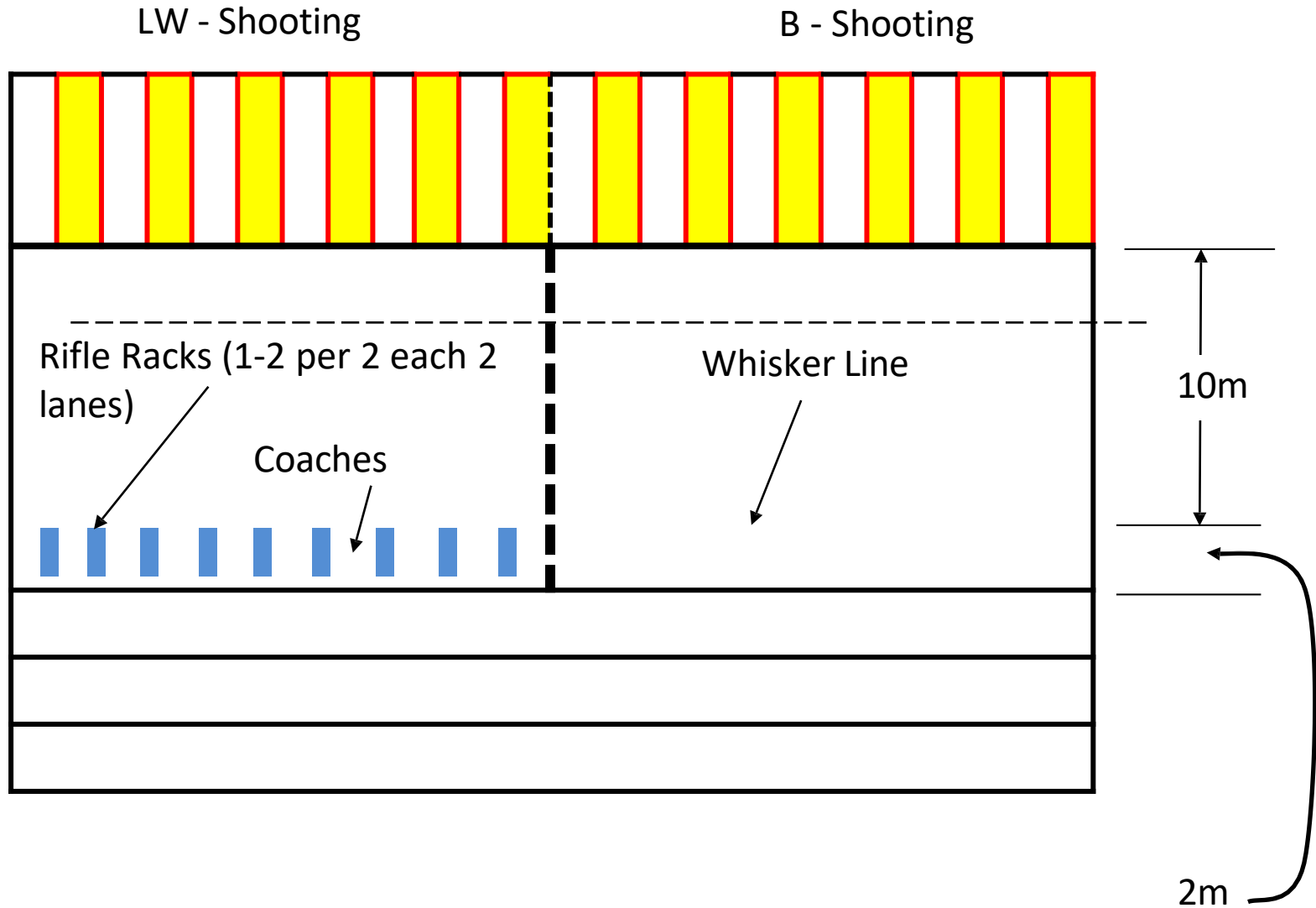



Annex 2: Range and Equipment Checklist

Venue: _____

Address: _____

Contact: _____

Date of Inspection: _____

Inspector: _____

Shooting Range

| | | |
|--|------------------------------|-----------------------------|
| Para Biathlon Range Inside Existing IBU 50m Range | <input type="checkbox"/> Yes | <input type="checkbox"/> No |
| Para Biathlon Range Temporary Range | <input type="checkbox"/> Yes | <input type="checkbox"/> No |
| Suitable for WC, 24 Lanes | <input type="checkbox"/> Yes | <input type="checkbox"/> No |
| Suitable for WSC, 26 Lanes | <input type="checkbox"/> Yes | <input type="checkbox"/> No |
| Suitable for PWG, 30 Lanes | <input type="checkbox"/> Yes | <input type="checkbox"/> No |
| Target to Firing Line Distance Correct | <input type="checkbox"/> Yes | <input type="checkbox"/> No |
| Target Height Above Firing Line Correct | <input type="checkbox"/> Yes | <input type="checkbox"/> No |
| Air Rifle Targets by Approved Manufacturer | <input type="checkbox"/> Yes | <input type="checkbox"/> No |
| Air Rifle Targets Automated | <input type="checkbox"/> Yes | <input type="checkbox"/> No |
| Air Rifle Electrical Power for Automated System | <input type="checkbox"/> Yes | <input type="checkbox"/> No |
| Air Rifle Targets Integrated with Results System | <input type="checkbox"/> Yes | <input type="checkbox"/> No |
| Air Rifle Targets Manual Reset and Scoring | <input type="checkbox"/> Yes | <input type="checkbox"/> No |
| Air Rifle Shooting Diameter 13mm | <input type="checkbox"/> Yes | <input type="checkbox"/> No |
| VI Shooting Targets by Approved Manufacturer | <input type="checkbox"/> Yes | <input type="checkbox"/> No |
| VI Shooting Targets Integrated with Results System | <input type="checkbox"/> Yes | <input type="checkbox"/> No |
| VI Shooting Targets Manual Scoring | <input type="checkbox"/> Yes | <input type="checkbox"/> No |
| VI Shooting Target Software Current | <input type="checkbox"/> Yes | <input type="checkbox"/> No |
| VI Shooting Display Software Current | <input type="checkbox"/> Yes | <input type="checkbox"/> No |
| VI Shooting Rifle Software Current | <input type="checkbox"/> Yes | <input type="checkbox"/> No |
| VI Shooting Headphone Sound 85db Current Setting | <input type="checkbox"/> Yes | <input type="checkbox"/> No |



| | | |
|---|------------------------------|-----------------------------|
| VI Shooting Chip Reader Reset | <input type="checkbox"/> Yes | <input type="checkbox"/> No |
| VI Shooting Athlete Chips Total Number | <input type="text"/> | |
| Electrical Power System for VI Shooting System | <input type="checkbox"/> Yes | <input type="checkbox"/> No |
| Shooting Lane Widths | <input type="text"/> | |
| Shooting Lanes for Air Rifle Total Number | <input type="text"/> | |
| Shooting Lanes for VI Shooting Total Number | <input type="text"/> | |
| LW Shooting Lanes Right or Left | <input type="text"/> | |
| Range Firing Line Board | <input type="checkbox"/> Yes | <input type="checkbox"/> No |
| Range Shooting Lane Dividers | <input type="checkbox"/> Yes | <input type="checkbox"/> No |
| Target Placement Within 90 degrees | <input type="checkbox"/> Yes | <input type="checkbox"/> No |
| Behind Target Area Whited out for WC | <input type="checkbox"/> Yes | <input type="checkbox"/> No |
| Wall Behind Target Area for WSC | <input type="checkbox"/> Yes | <input type="checkbox"/> No |
| Wall and roof for PWG | <input type="checkbox"/> Yes | <input type="checkbox"/> No |
| Distance from Front of Target to Wall Minimum 50cm | <input type="checkbox"/> Yes | <input type="checkbox"/> No |
| Clock (time of day) Between LW and B Shooting Lanes | <input type="checkbox"/> Yes | <input type="checkbox"/> No |
| Electrical Power System for Clock | <input type="checkbox"/> Yes | <input type="checkbox"/> No |
| Monitors for PWG 1 for Each 4 Lanes | <input type="checkbox"/> Yes | <input type="checkbox"/> No |
| Wind Flags every 2nd Lane for Air Rifle | <input type="checkbox"/> Yes | <input type="checkbox"/> No |
| Wind Flags Correct Distance from Firing Line | <input type="checkbox"/> Yes | <input type="checkbox"/> No |
| Wind Flags Correct Height | <input type="checkbox"/> Yes | <input type="checkbox"/> No |
| Lane Number Signs at Shooting Mats | <input type="checkbox"/> Yes | <input type="checkbox"/> No |
| Lane Shooting Numbers Correct Size and Height | <input type="checkbox"/> Yes | <input type="checkbox"/> No |
| Target Signs Correct Size and Position | <input type="checkbox"/> Yes | <input type="checkbox"/> No |
| T-Post Lane Divider Signs Correct size, Position & Height | <input type="checkbox"/> Yes | <input type="checkbox"/> No |
| T-Post Lane Dividers Number | <input type="text"/> | |
| All Range Signs in Correct Colors | <input type="checkbox"/> Yes | <input type="checkbox"/> No |
| LW Shooting Board Proper Size | <input type="checkbox"/> Yes | <input type="checkbox"/> No |
| LW Shooting Board Proper Position | <input type="checkbox"/> Yes | <input type="checkbox"/> No |
| B Shooting Boards Proper Size | <input type="checkbox"/> Yes | <input type="checkbox"/> No |
| B Shooting Boards Proper Position | <input type="checkbox"/> Yes | <input type="checkbox"/> No |
| Shooting Mats Proper Type and Size | <input type="checkbox"/> Yes | <input type="checkbox"/> No |



Athlete Area Size Correct

Yes No

Range Boxes (Coaching Staff, Media, VIP Proper Size)

Yes No

Range Boxes Wheelchair Access for VIP

Yes No

Rifle Racks Proper Type Total Number

Range Whisker Line

Yes No

Air Tanks 200bar Total Number

Air Tanks Adapters Both Types

Yes No

Air Tank Filling Station Distance from Range

Air Tank Method of Transport to Filling Station

LW Rifle Check Tables

Yes No

LW Rifle Check Equipment (trigger weight, balance point, measuring tool)

Yes No

LW Rifle Check Stickers

Yes No

LW Rifle Check Rifles Pointed in Safe Direction

Yes No

LW Rifle Check People Total Number

| | |
|----------------------|----------------------|
| <input type="text"/> | <input type="text"/> |
|----------------------|----------------------|

Range Safety Zones as per Para Nordic

Yes No

Range Safety Additional Zones as per Local Rules

Yes No

Range Overall Width

Range Overall Length

Zone of Silence Signs and Markings

Yes No

Neutralization Zone Marking Cones

Yes No

Neutralization Recording Paper

Yes No

LW Rifle Zeroing Paper Total Number

LW Zeroing Boards Total Number

LW Rifle Zeroing Paper Blanks

Scoring People 1st Line Total Number

Scoring People 2nd Line Total Number

Scoring People 3rd Line Total Number

Scoring Papers 1st, 2nd and 3rd Lines

Yes No

Scoring Board & Proper Paper

Yes No

Scoring Board People Total Number



Scoring Results Electronic Transmitting to Results Office

Yes No

Scoring Results Method of Transmitting to Results Office

Scoring Results Runners Total Number

Range Activity Cameras Total Number

Range Activity Cameras Memory Cards Total Number

Range Camera Power or Additional Batteries for Cold Operations

Yes No

Range Activity Cameras Memory Card to Jury Room

Yes No

Range Activity Cameras Wired to Jury Room for Live Viewing

Yes No

Range Activity Cameras Viewing PC in Jury Room

Yes No

Range Target Painting Paint Sticks

Yes No

Range Open and Closed Flags

Yes No

Range Spectator Area Located

Yes No

Range Operations Tools (brooms, shovels, rakes, levels, whistle etc.....)

Yes No

Range Operations Equipment Storage

Yes No

Range Operations People in Total Number

Comments:



Penalty Loop

Penalty Loop from Range Exit Proper Distance

Yes

Penalty Loop 80m

Yes

Penalty Loop 100m

Yes

Penalty Loop 150m

Yes

Penalty Loop Signs, Entrance and Distance

Yes

Penalty Loop Direction Proper

Yes

Penalty Loop Scoring Papers

Yes

Penalty Loop Data to Shooting Results Method

Yes

Penalty Loop Scoring People Total Number

Penalty Loop Camera

Yes

Penalty Loop Camera Memory Card Total Number

Penalty Loop Camera Memory Card to Jury Room

Yes

Penalty Loop Camera Live Wired to Jury Room for Live Viewing

Yes

Penalty Loop People in Total Number

Comments:

Documentation

As Built Drawings for Range and Penalty Loop

Yes

Summary Comments

