



TIMING BOOKLET

SNOWBOARD

FREESTYLE SKIING

Version 1.3 (26.09.2023)

1. Table of contents

1. Table of contents	1
2. Competition Levels.....	4
3. Equipment.....	5
3.1. Cable connection.....	5
3.2. Start Photo Cells ① ②	5
3.3. Start Clock ⑩.....	5
3.4. Voice Communication ⑧	5
3.5. Timing Cables.....	5
3.6. Photo Cells at Intermediate Time.....	5
3.7. Photo Cells at the Finish Line ③ ④	6
4. Timing Devices	8
4.1. System A Timer ⑤ and System B Timer ⑥	8
4.2. Manual hand timing ⑦	8
4.3. Photo Finish System ⑪	8
4.4. Transponders	8
5. Procedures	9
5.1. Synchronization.....	9
5.2. Competition in progress.....	9
5.3. Missed Time	9
5.4. Timing Report.....	9
5.5. Parallel Competition difference calculation	10
6. Timing without cable connection between Start and Finish	11
7. Setup-Up Examples	13
7.1. Moguls Set-Up for Level 1	13
7.2. Cross Qualification Set-Up for Level 1	14
7.3. Moguls and Cross Qualification Set-Up Level 2.....	15
7.4. Moguls and Cross Qualification Set-Up Level 4 (One Cable).....	16
7.5. Moguls and Cross Qualification Set-Up Level 4 (Without Cable)	17
7.6. Dual Moguls Set-Up Level 1	18
7.7. Dual Moguls Set-Up Level 2 to Level 4.....	19

7.8. Cross Set-Up Level 1 and Level 2	20
7.9. Cross Set-Up Level 3 and Level 4	21
7.10. Team Cross Set-Up for all Levels	22
7.11. Aerials Set-Up for all Levels.....	23
7.12. Parallel Set-Up Level 1 to Level 2.....	24
7.13. Parallel Set-Up Level 3 to Level 4 (Difference in Finish)	25
7.14. Parallel Set-Up Level 3 to Level 4 (Run Time)	26
7.15. Alpine Event Set-Up Level 1	27
7.16. Alpine Event Set-Up Level 2.....	28
7.17. Alpine Event Set-Up Level 3 (One Cable).....	29
7.18. Alpine Event Set-Up Level 4 (Without Cable)	30
8. Important ICR rules for Freestyle and Snowboard timing	31
8.1. Overall.....	31
8.2. Aerials	31
8.3. Moguls.....	31
8.4. Dual Moguls	31
8.5. Cross.....	32
8.6. Alpine Snowboard	32
9. EET Calculation	33
9.1. Example if System A and Backup Time has the precision of 1/1000 th	33
9.2. Example if System A and Backup Time has the precision of 1/10,000 th	34
9.3. Example if Using a Hand Time with 1/100 th	34
10. Timing & Data Technical Report Form	35
11. Criteria for FIS Approved Timing Devices FIS Competitions	36
11.1. Timers	36
11.2. Start Gate	37
11.3. Start Clock.....	40
11.4. Start Door	40
11.5. Photo Cell.....	43
11.6. Photo Finish Systems	45
12. Homologation of Timing Equipment	47
13. Conclusion	48



14. Change Log	49
14.1. Version 1.3, 26.09.2023.....	49
14.2. Version 1.2, 13.09.2022.....	49
14.3. Version 1.06, 13.09.2021.....	49
14.4. Version 1.05, 01.09.2021.....	50
14.5. Version 1.04	51
14.6. Version 1.03	51
14.7. Version 1.02	52

2. Competition Levels

All timing devices used, including start gates and photo cells must be homologated as per the homologated timing equipment list on the FIS website: <https://www.fis-ski.com/DB/information/homologated-timing-equipment.html>

Competitions using devices not mentioned on that list will not be considered for FIS points.

Please note references to competition Level classification as listed here:

Level	Category	Code
1	Olympic Winter Games	OWG
1	World Ski/Snowboard Championships	WSC
1	World Cup	WC
1	Qualification	QUA
2	Youth Olympic Winter Games	YOG
2	Junior World Championships	WJC
2	Universiade	UVS
2	Australian New Zealand Cup	ANC
2	European Cup	EC
2	South American Cup	SAC
2	Nor-Am Cup	NAC
2	Asian Cup	AC
2	Super Continental Cup	SCOC
2	FIS Open	OPN
3	National Championships	NC
4	European Youth Olympic Festival	EYOF
4	National Junior Championships	NJC
4	FIS	FIS
4	Junior	JUN
4	Children	CHI
4	Masters	MAS
4	Asian Winter Games	AWG
4	Para Events	PARA

Cabling of a higher category can also be used. (e.g., Level 3 can use the same setup as Level 2 or Level 1). If the competition category is not listed in the classification table, it should use the setup as defined for Level 4.

3. Equipment

3.1. Cable connection

For all competition levels except Level 1, timing without cable connection from the Start is permitted for both A and B timing systems. Refer to set-up diagrams that describe in detail how this may be achieved.

Attention: The cable dedicated to timing functions must be reserved for that purpose only and must be protected from any interference (e.g., speaker systems, snow gun data, etc.). No technical changes during the competition that may alter the transmission of trigger signals (length, capacitance, resistance, etc.) may be made.

The organizer must ensure that cable conduits and other cable runs do not interfere with timing cable functions. It is highly recommended that expert technical testing and verification of these timing cables be performed to assure timing cable integrity.

3.2. Start Photo Cells ① ②

Locate photo cells carefully in co-ordination with the Technical Delegate and/or the Competition Jury. Please refer to the attached section that explains photo cell use.

3.3. Start Clock ⑩

Can show time of day, and countdown status, but must have acoustic signal. Must be synchronized with the other timing systems.

3.4. Voice Communication ⑧

Timing impulse and voice communication functions must be separated on different wire pairs if manufacturer's specifications dictate.

If radios are used for voice communication, a dedicated channel must be used.

3.5. Timing Cables

Make sure that cables cannot be torn out at the start by a competitor, or by any other person next to the starting area.

Optical Cables: If a converter is necessary between timing cables and optical cables, then the converter must be approved by FIS.

3.6. Photo Cells at Intermediate Time

Locate photo cells carefully in co-ordination with the Technical Delegate and/or the Competition Jury.

To avoid the cells being triggered by anyone other than the competitors, it is recommended that the person responsible for an intermediate timing point uses a push-button to arm the photo cells only when a competitor crosses the line.

3.7. Photo Cells at the Finish Line ③ ④

Please refer to the attached section that explains photo cell use.

Wire must be used to connect photo cells to the timer. Wireless is not allowed.

The use of a homologated timer with printer installed at the Finish line directly attached to the photo cells is recommended for Level 2 and Level 1 competitions or any time a lengthy wire connection to the Finish area from the timing cabin is used.

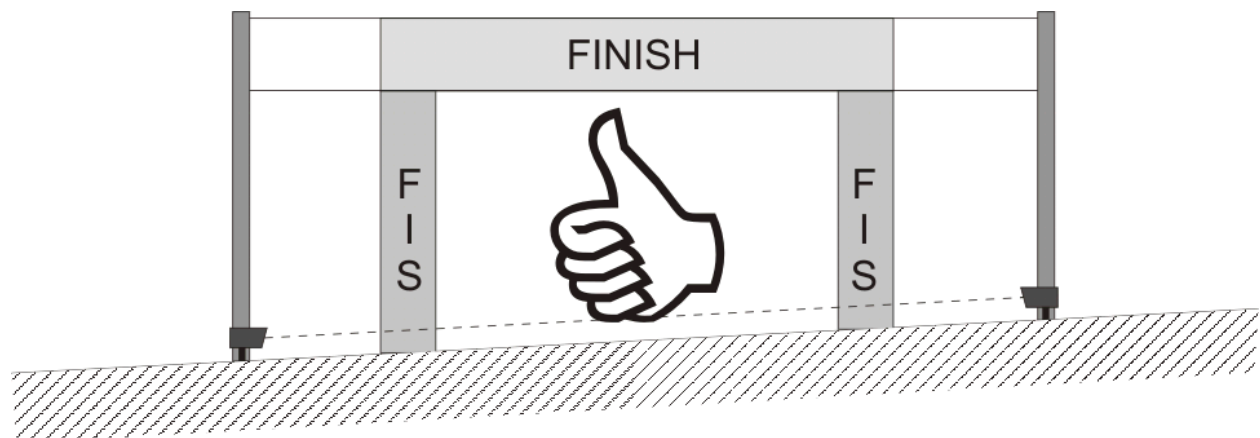

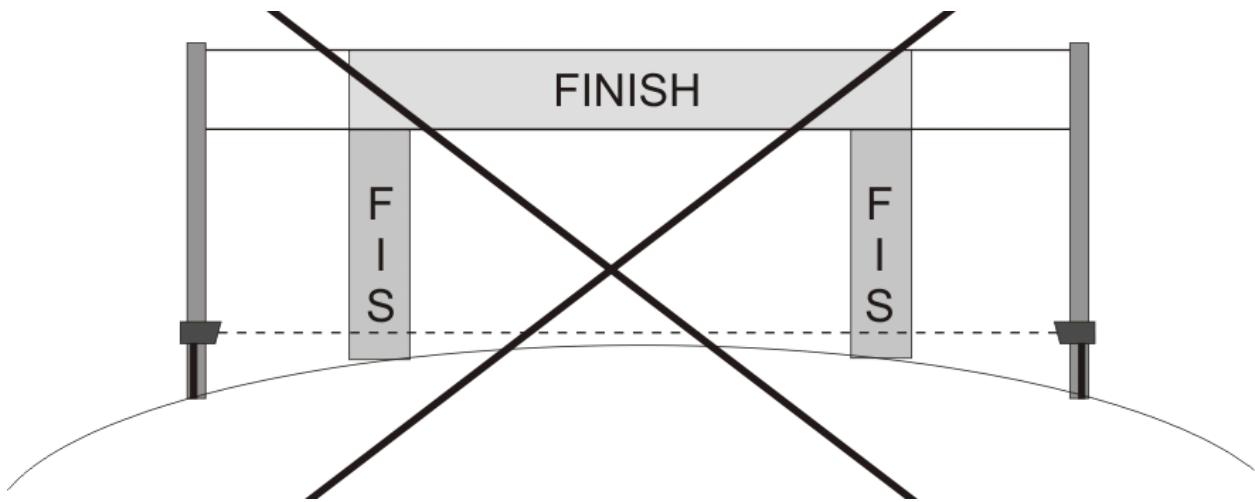
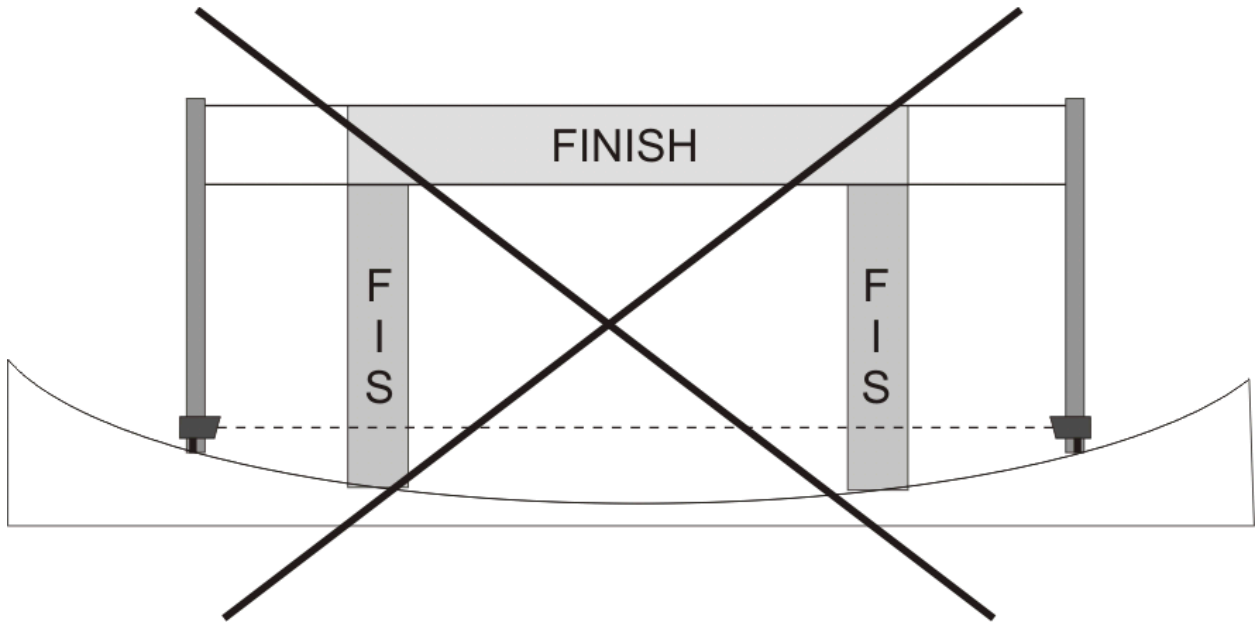

4. Timing Devices

4.1. System A Timer ⑤ and System B Timer ⑥

Start line ① and finish photo cell ③ must be connected.

Start line ② and finish photo cell ④ must be connected.

The use of any electronic device (e.g., optocoupler and impulse distributors) between start gate and timer or photo cell and timer must be specifically compatible and authorized by the manufacturers.

When no hill cable between start and finish is installed, homologated timers ⑨ must be used.

Time of day times must be immediately and automatically sequentially recorded on printed strips at the maximum precision of the timing device according to the requirements for homologation.

4.2. Manual hand timing ⑦

In all cases for all competitions at all levels, hand timing is mandatory.

Stopwatches, with or without printers, showing times to at least 1/100th second should be synchronized to the time of day and used at the start and at the finish.

A complete list of hand times recorded at the start and the finish must be given to the Chief of Timing at the end of each run or immediately upon request.

4.3. Photo Finish System ⑪

A photo finish system with synchronized time of day mode may be used for backup reasons at the finish line.

4.4. Transponders

Transponders are not to be used as official time (for system A and B).

5. Procedures

5.1. Synchronization

All elements of the timing installation must be installed and be in good working order at least one hour before the beginning of the competition.

The synchronisation impulse for all timers must come from one single source (one contact) for all timing devices. After synchronisation is done, a new impulse must be sent by the same source to check synchronisation accuracy on Systems A and B. The maximum allowed difference between system A and B is 0.001 seconds.

Should any important discrepancies be observed when this check is performed, synchronisation should be redone and checked again prior to the start of the run.

Manual stopwatch synchronisation must be done before or together with the synchronisation of the whole system.

5.2. Competition in progress

In case of timing problems, the Chief of Timing must inform members of the Jury or the Finish Referee immediately.

Starter and official timekeeper should agree upon using specific terms and commands during communication. This dialogue should be short and precise, as well as systematically repeated for each competitor. In all cases it is recommended that the starter always informs the timekeeper(s) at the finish before and after a competitor leaves the start.

At the end of each run or competition, before sending out the results, times and ranking from the timing systems and the computer results system must be compared and cross checked for accuracy.

5.3. Missed Time

A missed time is a time of day that is not shown on the printed tape of the system A timer. If a time from system B is missed but you have it printed on system A it is not considered as a missed time.

In case you have a missed time of system A and must replace it by time of day of system B or of a hand time, then you have to recalculate the missed time as described in the [EET Calculation chapter](#).

5.4. Timing Report

At the end of the competition, it is compulsory to send the “Timing & Data Technical Report Form” to FIS for the following Snowboard and Freestyle competitions (see section [Timing & Data Technical Report Form](#) in this booklet):

- Alpine Snowboard
- Ski and Snowboard Cross
- Moguls and Dual Moguls

The printed tapes from the System A, System B and all hand timing records must be handed to the competition organization who must keep them at least 3 months after the competition or after any appeal dealing with timing.

A member of the Timing Working Group could check at any time and at any competition the timing system connection. A contact of each starting line and finish photo cell must be available to connect a FIS timing device. Of course, such connection will be done at least 2 hours before the competition or training start and not during the competition or training.

5.5. Parallel Competition difference calculation

For any parallel competition where only difference is measured at the finish line (e.g., Parallel Giant Slalom or Dual Moguls), it is important to correctly calculate the difference. First the difference from unmodified time of day is calculated and only then truncated to the desired precision in order to get the published difference time.

Difference Time Calculated from Finish Times	Red	Blue
Finish Time	10:00:34.345	10:00:34.341
Calculated Difference Time	00:00:00.004	
Published Difference Time	0.00	

6. Timing without cable connection between Start and Finish

FIS Timing Working Group recognizes the importance of allowing emerging and technically responsible technologies to be used in modern FIS competitions. For this reason, and because of the flexibility that it affords, FIS Level 3 and 4 competitions may use timing solutions that do not require any hard wire connection between start and finish for either A and/or B systems. Level 2, 1 and 0 competitions are not allowed to use this solution, this could be only permitted in situations of force majeure.

The FIS does not homologate wireless timing technology for use in FIS skiing events. The FIS certifies timing equipment (timers, start gates, photocells, other devices) for use with hard-wired connections between start and finish locations as a general standard.

Regardless of the technology being used, every solution without hill cable must include the use of homologated timers operating in synchronized Time-of-Day with active printers or data memory. Systems will be represented by homologated timer(s) at the start and homologated timer(s) at the finish. Please refer to the set-up diagram that illustrates the correct use of this technique.

All timing rules remain in force in this situation (set-up, synchronization, time-of day precision, printing, hand timing). In addition, for race results to be valid the TD must gather and submit to FIS all timer printer tapes or data memory with the Timing Technical Report Forms. The "no-wires" aspect of this technique provides the time-of-day start times and the time-of-day finish times from the separate, synchronized timing devices. In all cases the start and finish sensors must still be connected to the start and finish timers using hard-wire connections.

The Chief of Timing must make sure that all wireless solutions adopted work in the physical environment of the start and finish regardless of the weather conditions and temperature.

This allows race organizers to use many types of timing solutions without wires if these timers are in place and are used to verify the results.

If times are generated by a timing solution other than system A or B in all cases these times must be checked against system A and must match exactly. In case results deviate from system A, the competition must be evaluated on the A system times as per the normal timing set-up rules and procedures.

When a radio system with impulse transmission is used, the accuracy must be consistent within +/- 1/1000 second. The accuracy must be clearly described in the manual for the radio system. FIS rules must be applied if a time from system B is used.

In practice the timing-without-wires solution must consider how to prove that times from all start and finish sensors are valid in the Time-of-Day ("ToD") methods normally used.

Thus, ANY additional wireless solution from ANY manufacturer that allows for comparison to these ToD start and finish times (recorded and preserved at each homologated timer) could be

used. How the wireless transmission is achieved (impulse, data, GPS, Network, voice, paper) is open for use, but it must be able to match the ToD proof captured on the homologated devices at start and finish in ToD.

In all cases where no-wire solutions are used the timing tapes or data memory files must be sent with the results to the FIS. A description of techniques that demonstrate how the calibration issues between the time bases are dealt with over runs is also essential to be provided to FIS, since synchronization could be an important element as evidence.

In all cases where wireless equipment will be used, it is highly recommended that Race Organizers or assigned FIS Technical Delegates check with a member of the FIS Timing Working Group in advance of the competition to describe the intended wireless equipment set-up and to verify test data.

Please refer to the set-up diagram that illustrates the correct use of this technique.

- Moguls and Cross Qualification Set-Up Level 4 (Without Cable) (see [7.5](#))
- Alpine Event Set-Up Level 4 (Without Cable) (see [7.18](#))

7. Setup-Up Examples

7.1. Moguls Set-Up for Level 1

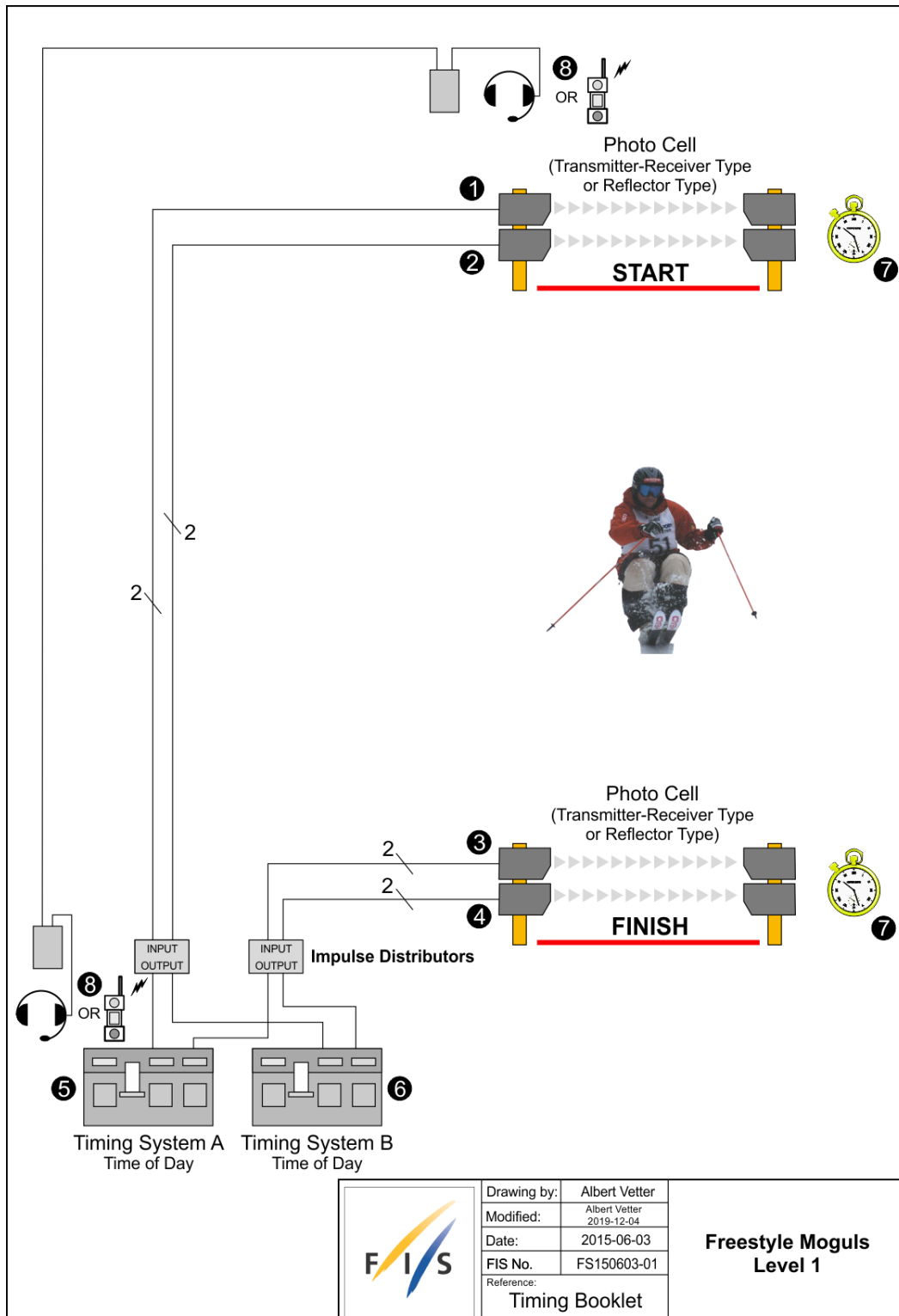

Drawing by:	Albert Vetter
Modified:	Albert Vetter 2019-12-04
Date:	2015-06-03
FIS No.	FS150603-01
Reference:	Timing Booklet

**Freestyle Moguls
Level 1**

7.2. Cross Qualification Set-Up for Level 1

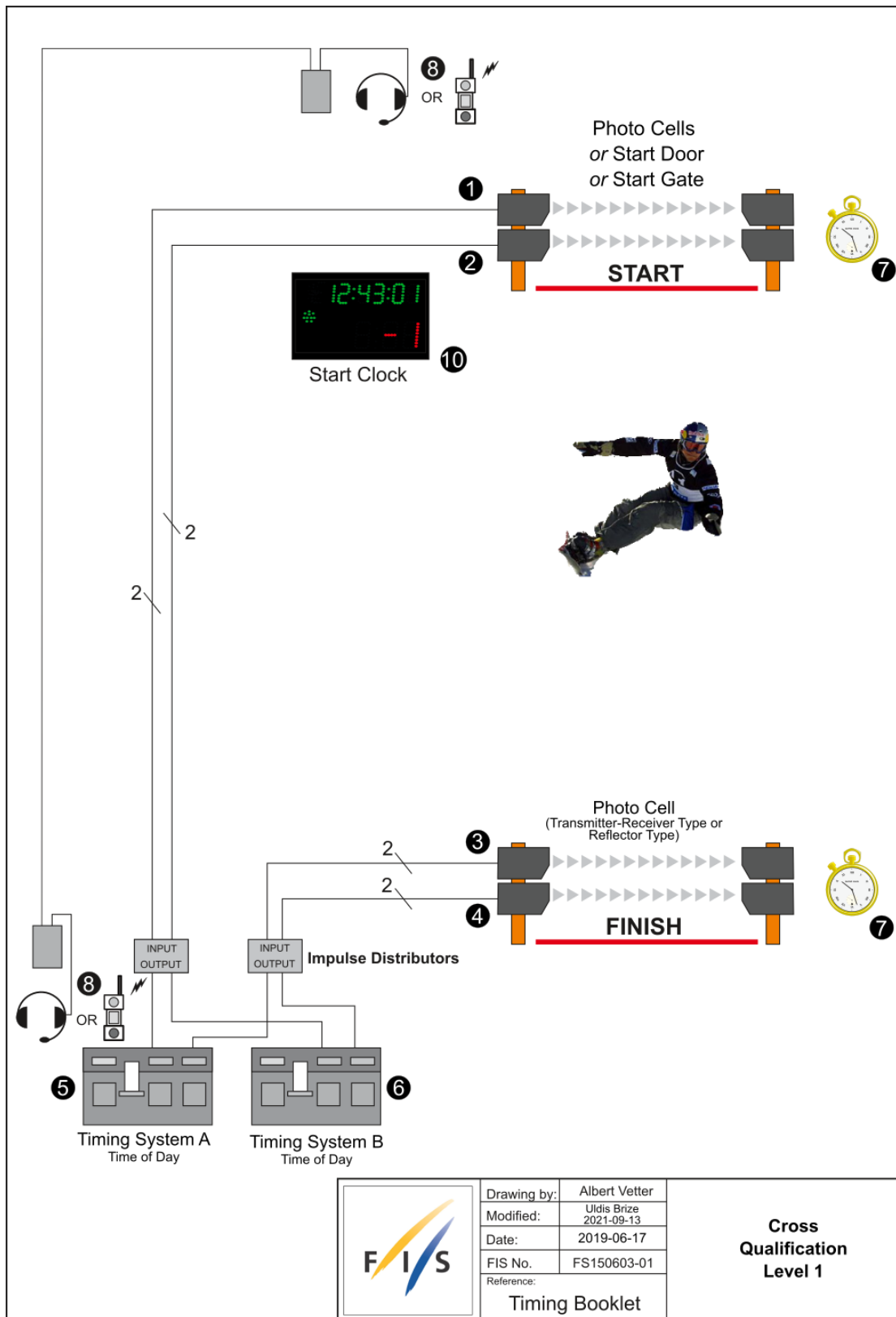

7.3. Moguls and Cross Qualification Set-Up Level 2

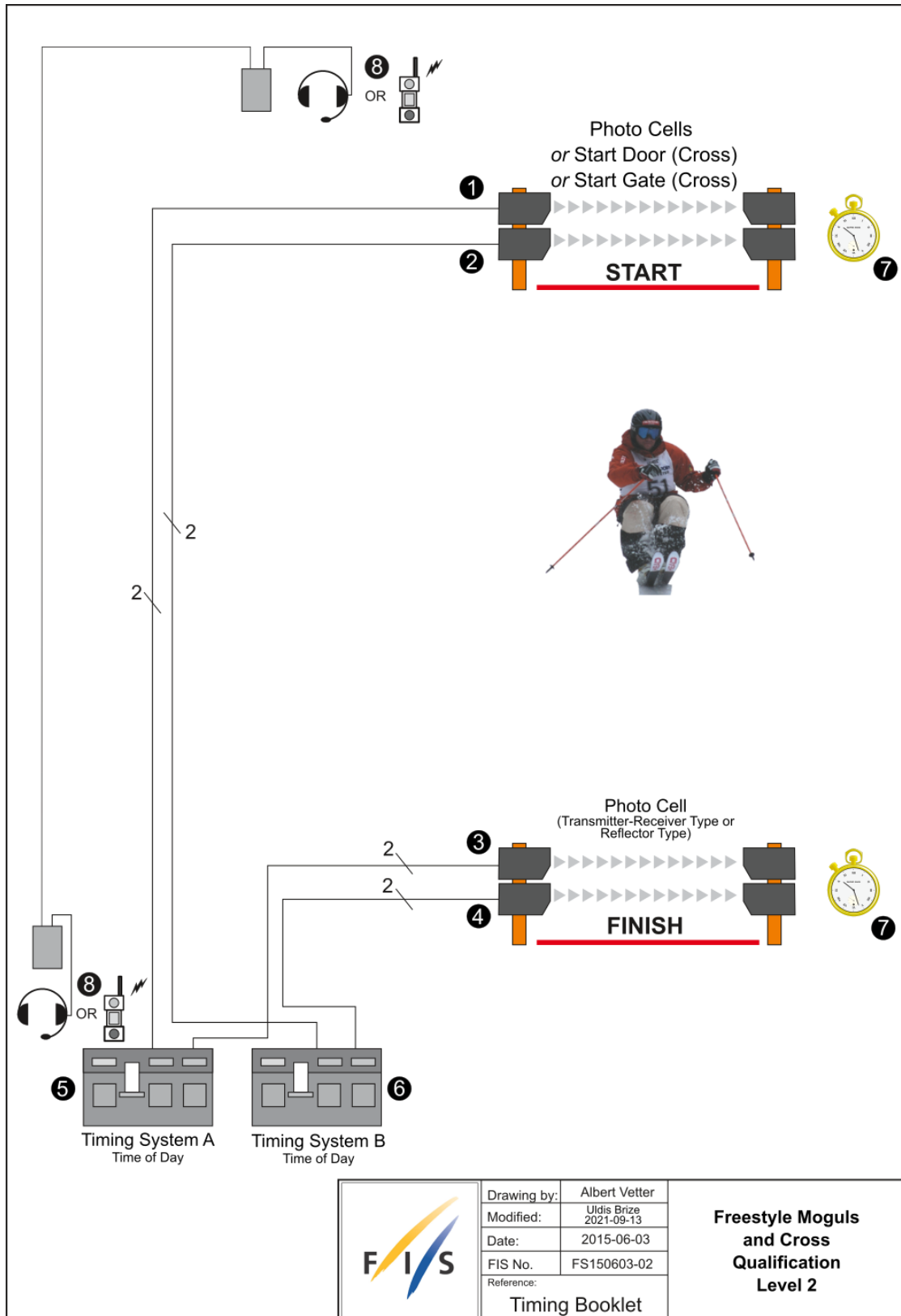

7.4. Moguls and Cross Qualification Set-Up Level 4 (One Cable)

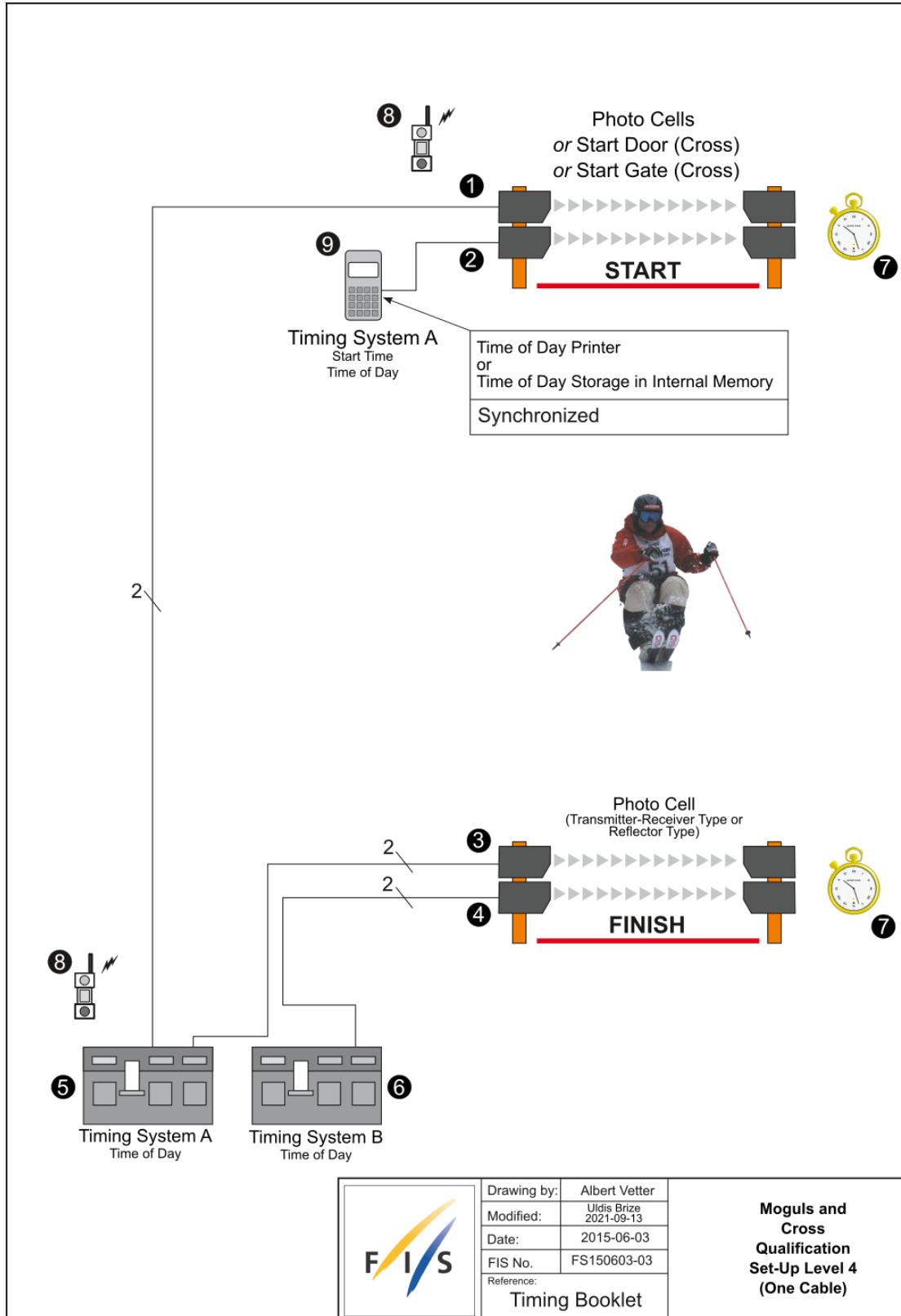

7.5. Moguls and Cross Qualification Set-Up Level 4 (Without Cable)

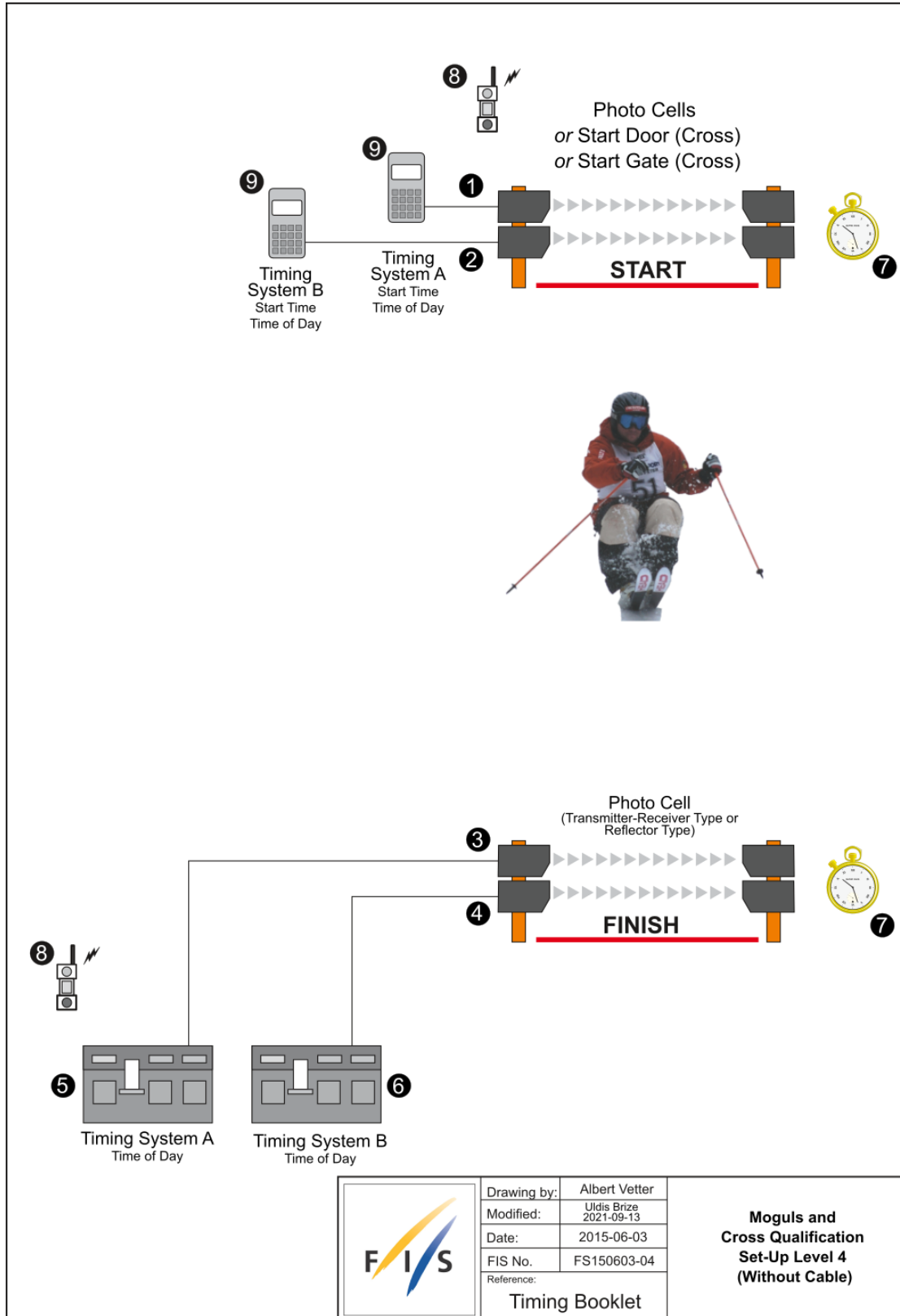

7.6. Dual Moguls Set-Up Level 1

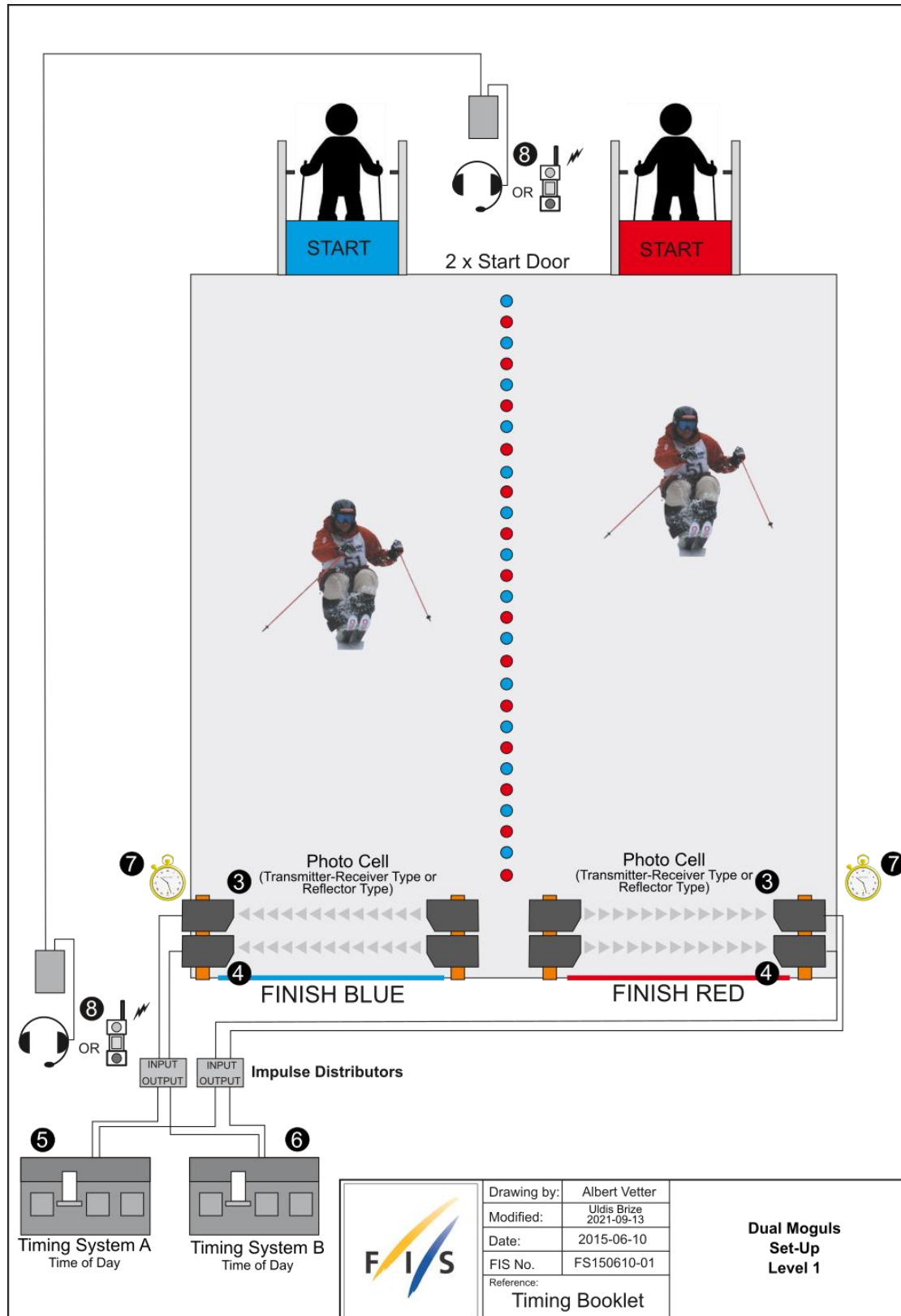

Drawing by:	Albert Vetter
Modified:	Uldis Brize 2021-09-13
Date:	2015-06-10
FIS No.	FS150610-01
Reference:	Timing Booklet

**Dual Moguls
Set-Up
Level 1**

7.7. Dual Moguls Set-Up Level 2 to Level 4

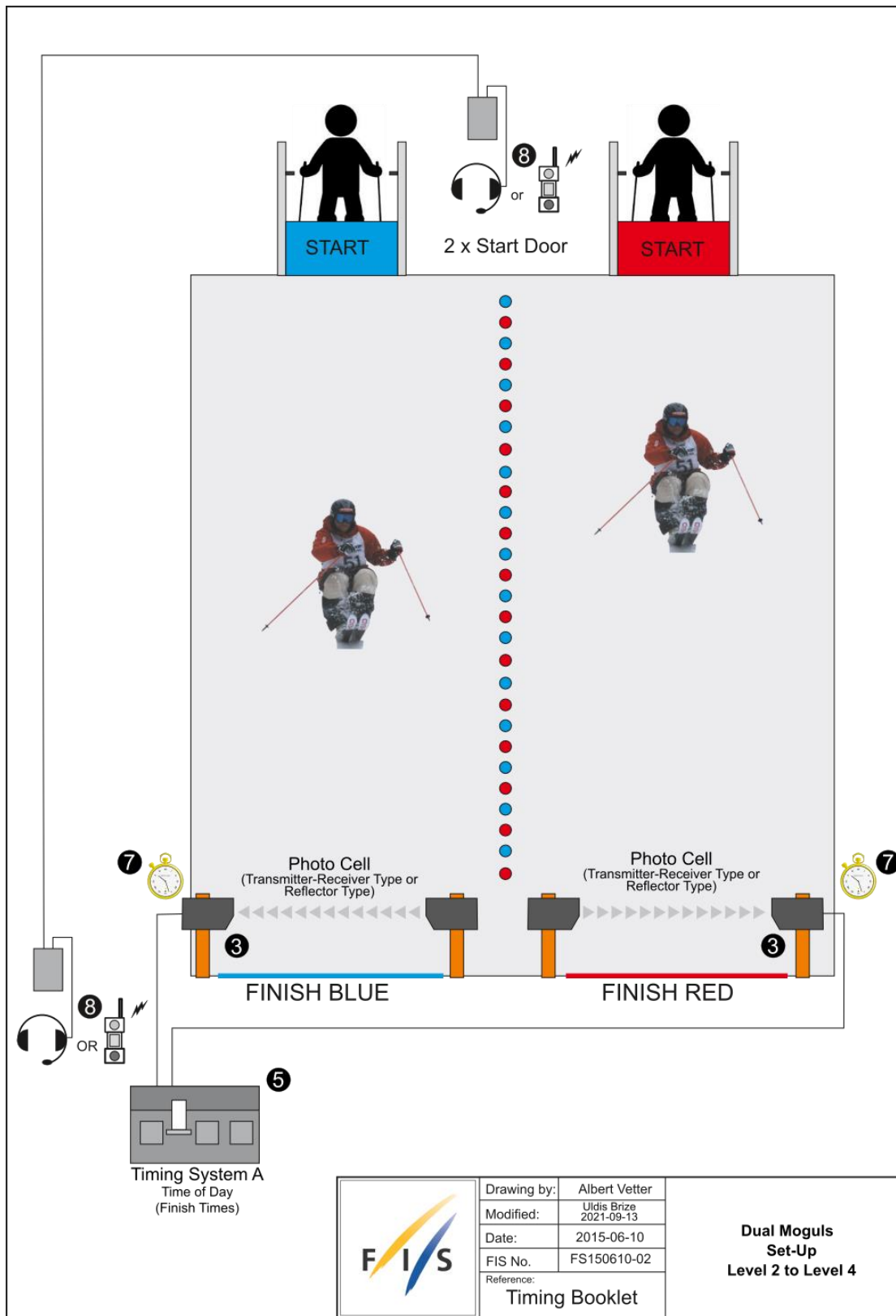

	Drawing by:	Albert Vetter
	Modified:	Uldis Brize 2021-09-13
	Date:	2015-06-10
	FIS No.	FS150610-02
Reference:		Timing Booklet

**Dual Moguls
Set-Up
Level 2 to Level 4**

7.8. Cross Set-Up Level 1 and Level 2

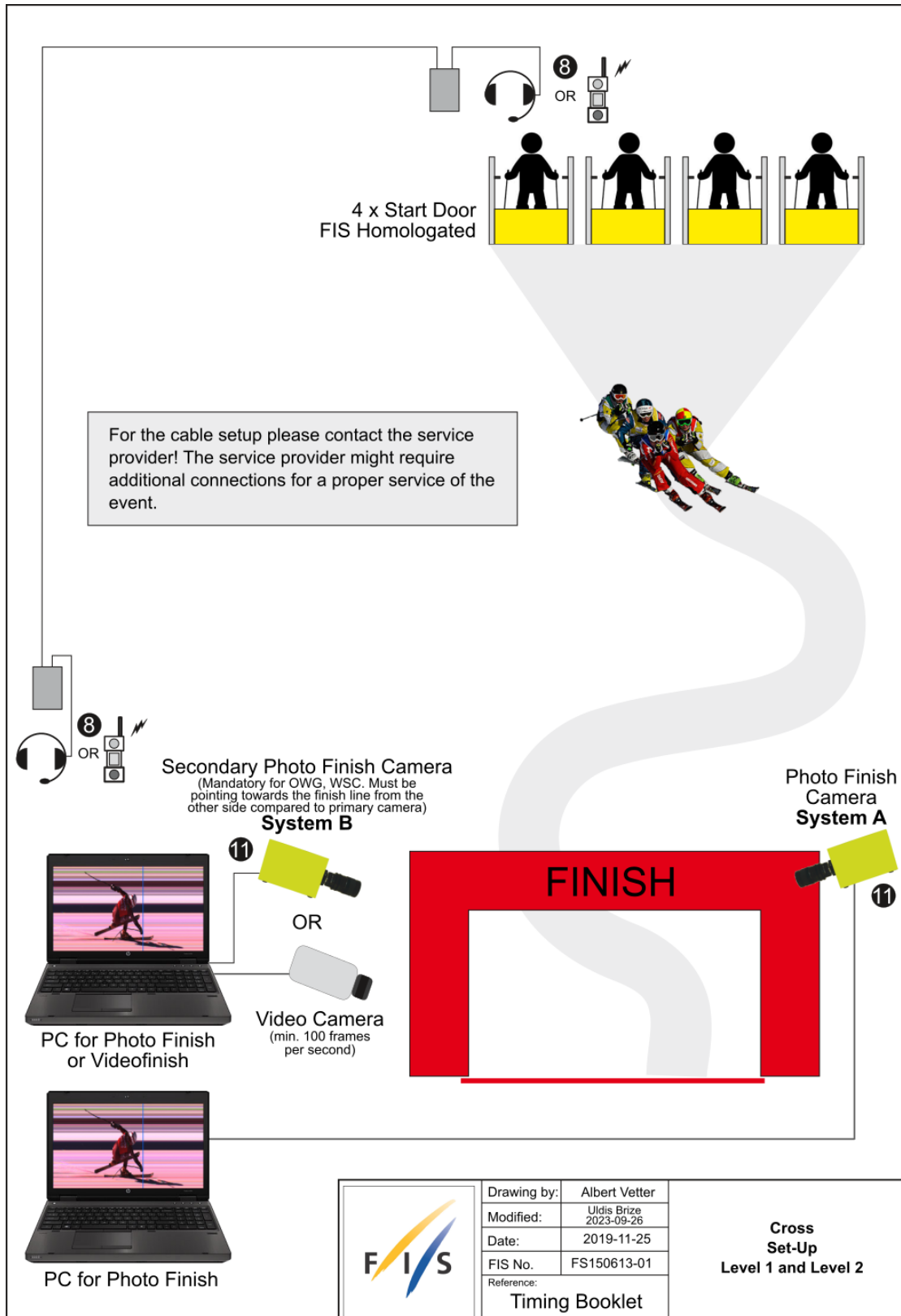

7.9. Cross Set-Up Level 3 and Level 4

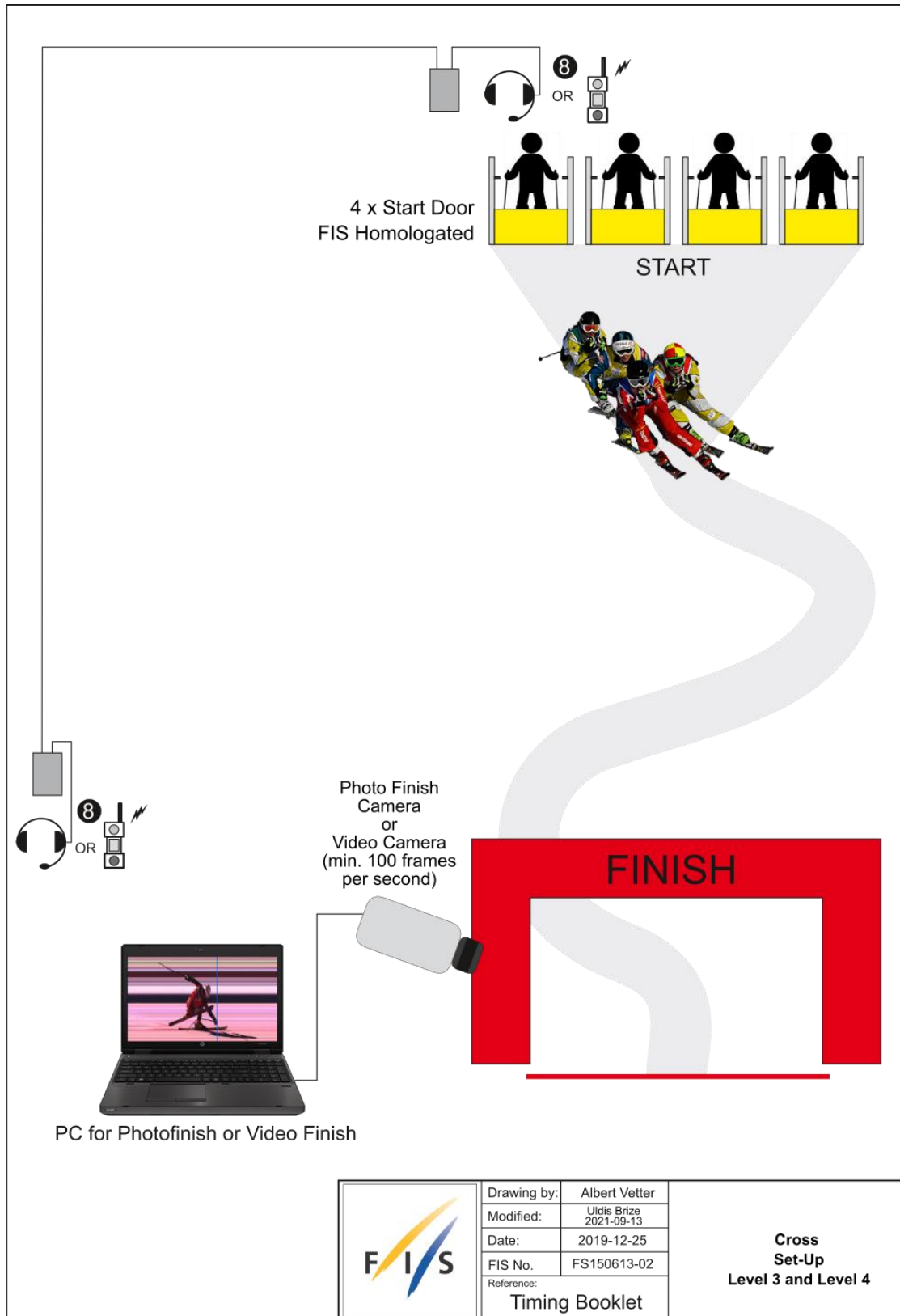

7.10. Team Cross Set-Up for all Levels

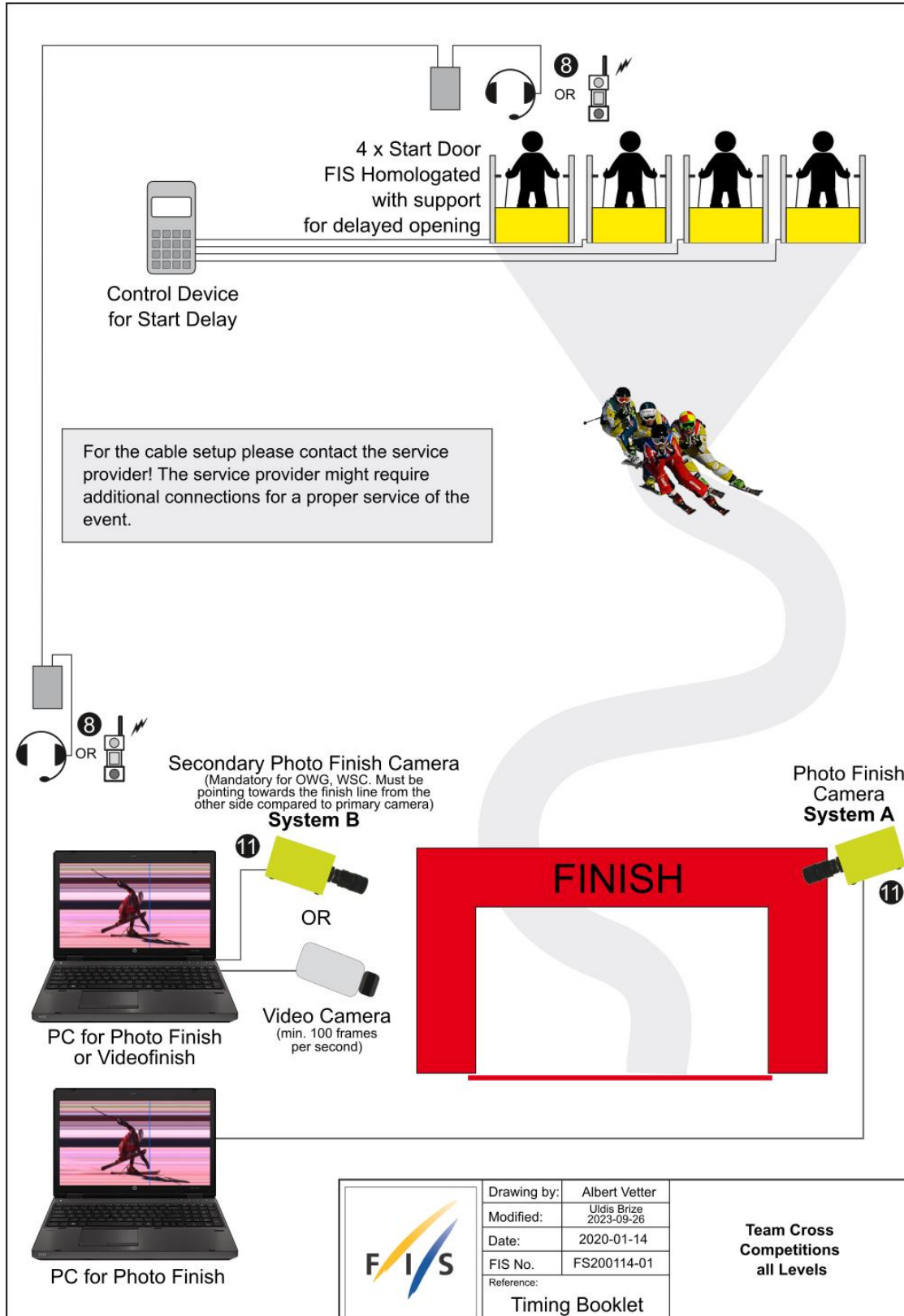

7.11. Aerials Set-Up for all Levels

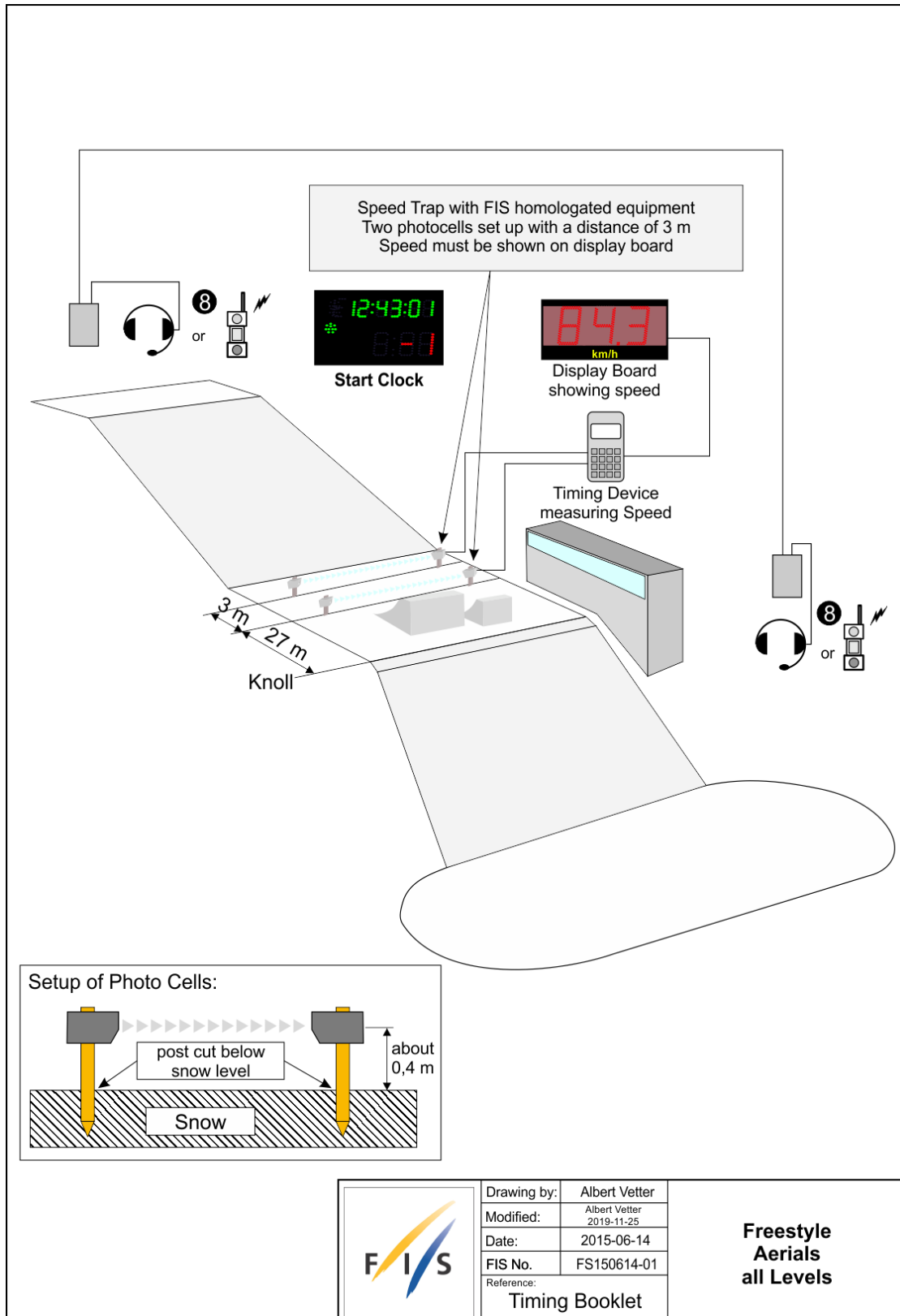

7.12. Parallel Set-Up Level 1 to Level 2

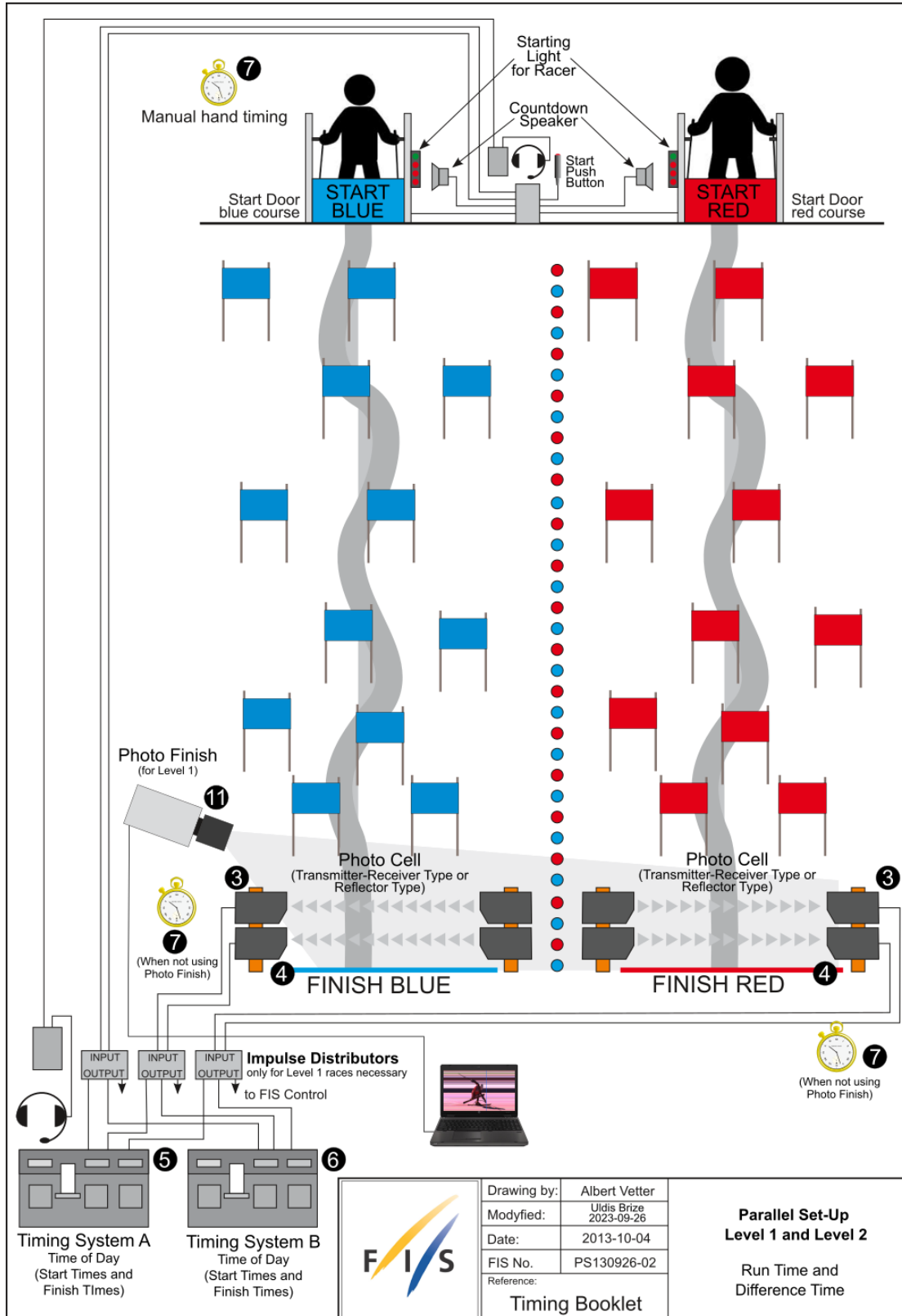

Timing System A
Time of Day
(Start Times and
Finish Times)

Timing System B
Time of Day
(Start Times and
Finish Times)



Drawing by: Albert Vetter
Modified: Uldis Brize
2023-09-26
Date: 2013-10-04
FIS No. PS130926-02
Reference:
Timing Booklet

**Parallel Set-Up
Level 1 and Level 2**

Run Time and
Difference Time

7.13. Parallel Set-Up Level 3 to Level 4 (Difference in Finish)

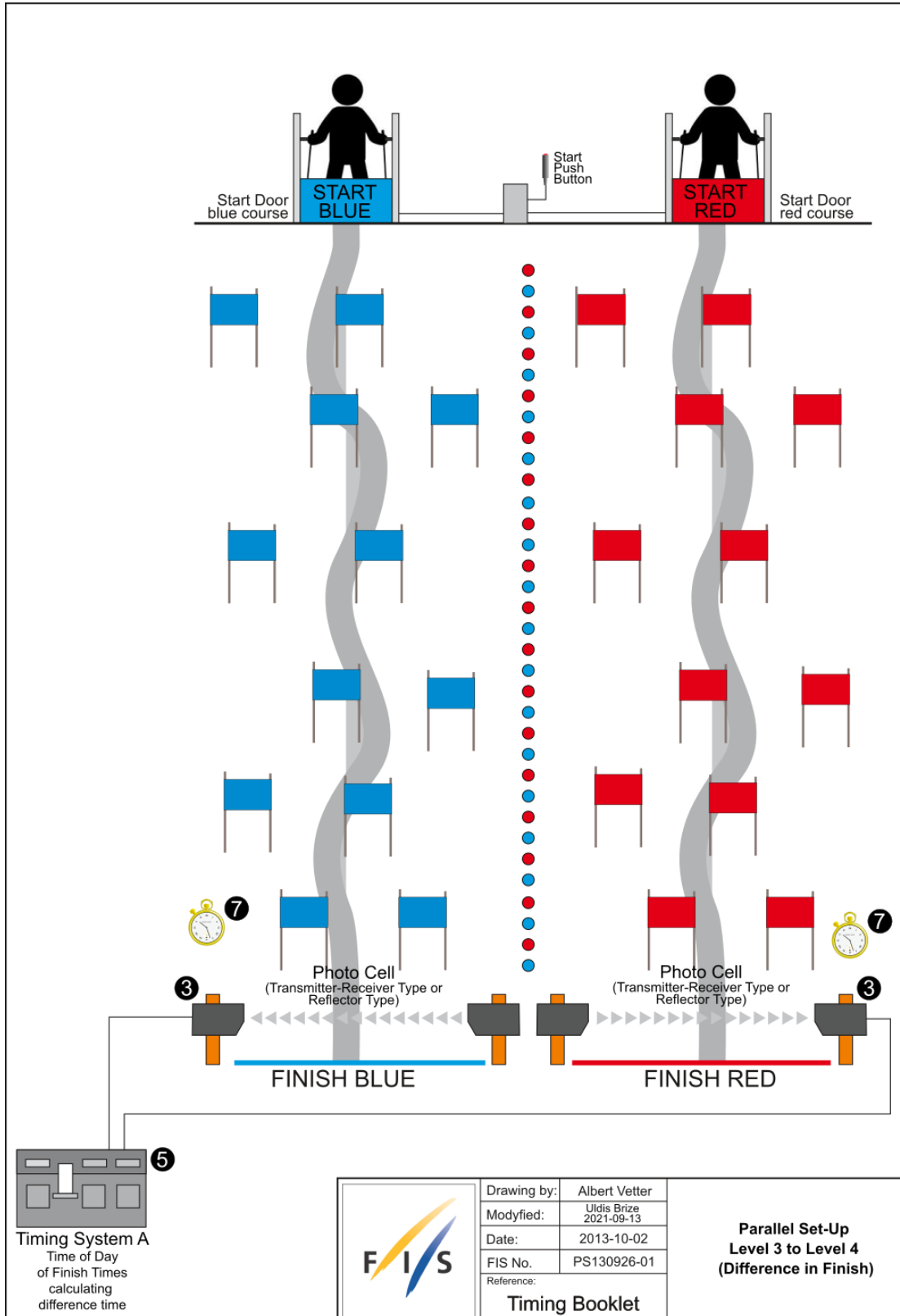

Timing System A
Time of Day
of Finish Times
calculating
difference time



Drawing by:	Albert Vetter
Modified:	Uldis Brize 2021-09-13
Date:	2013-10-02
FIS No.	PS130926-01
Reference:	

Timing Booklet

**Parallel Set-Up
Level 3 to Level 4
(Difference in Finish)**

7.14. Parallel Set-Up Level 3 to Level 4 (Run Time)

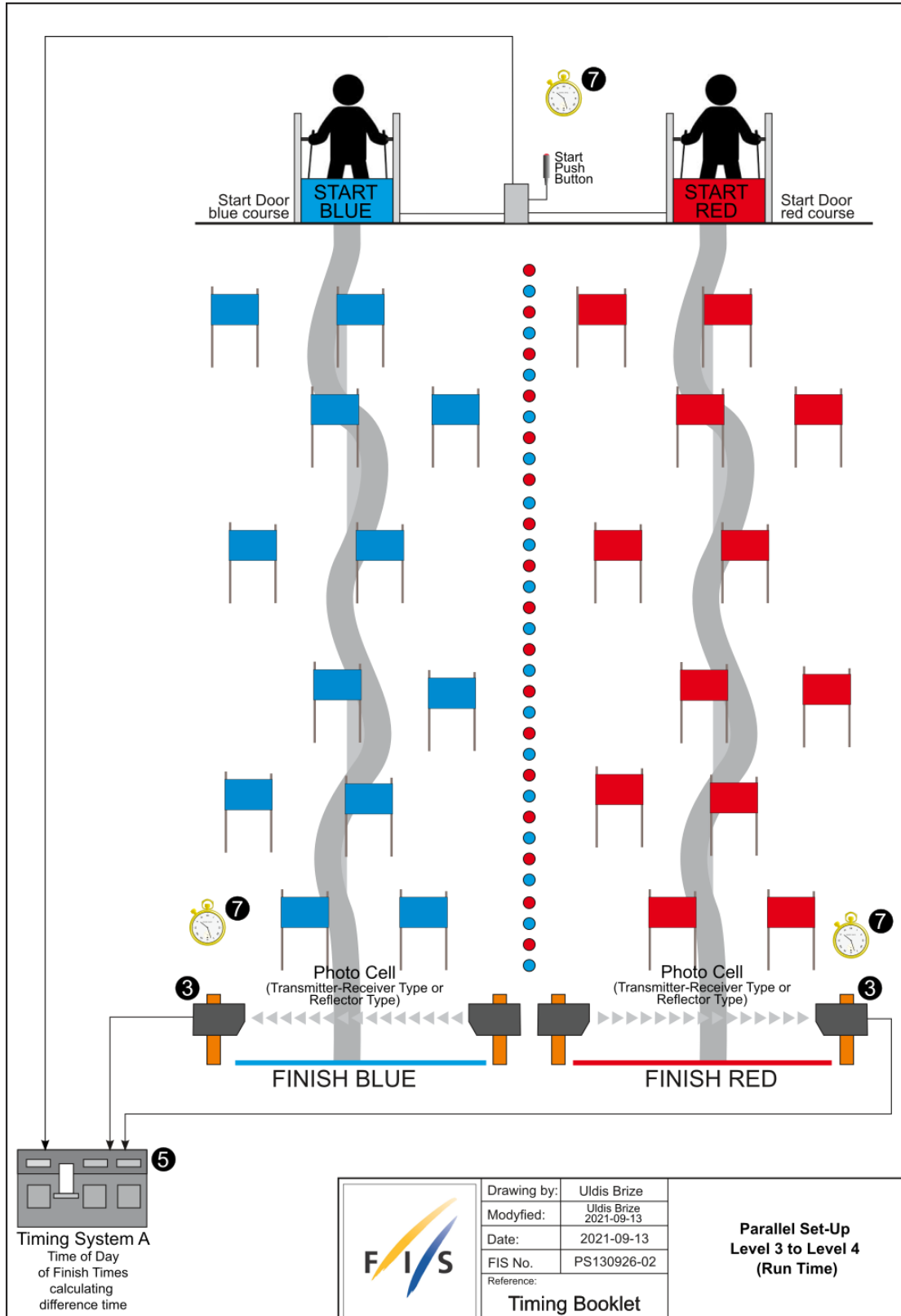

7.15. Alpine Event Set-Up Level 1

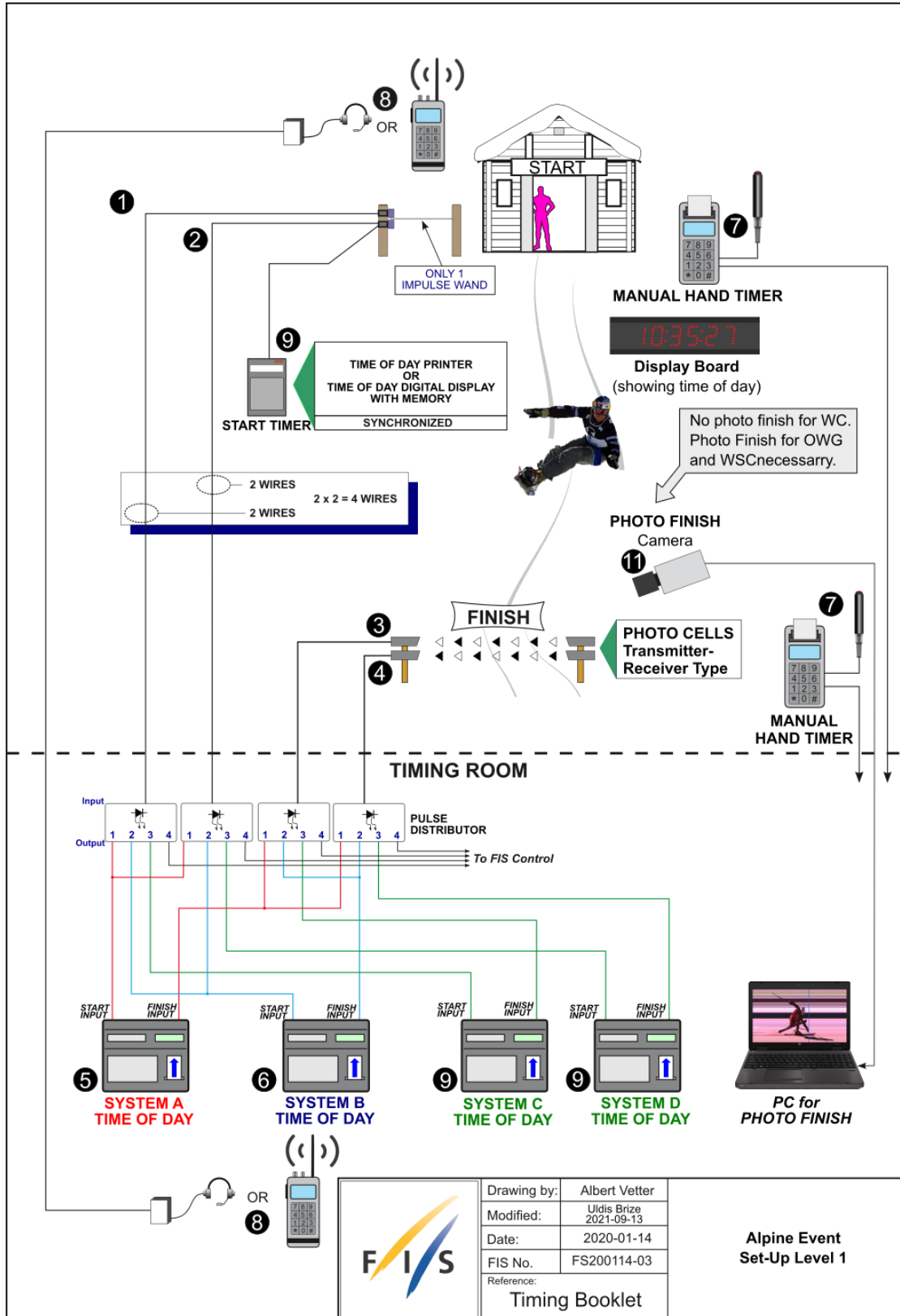

Drawing by:	Albert Vetter
Modified:	Uldis Brize 2021-09-13
Date:	2020-01-14
FIS No.	FS200114-03
Reference:	Timing Booklet

Alpine Event
Set-Up Level 1

7.16. Alpine Event Set-Up Level 2

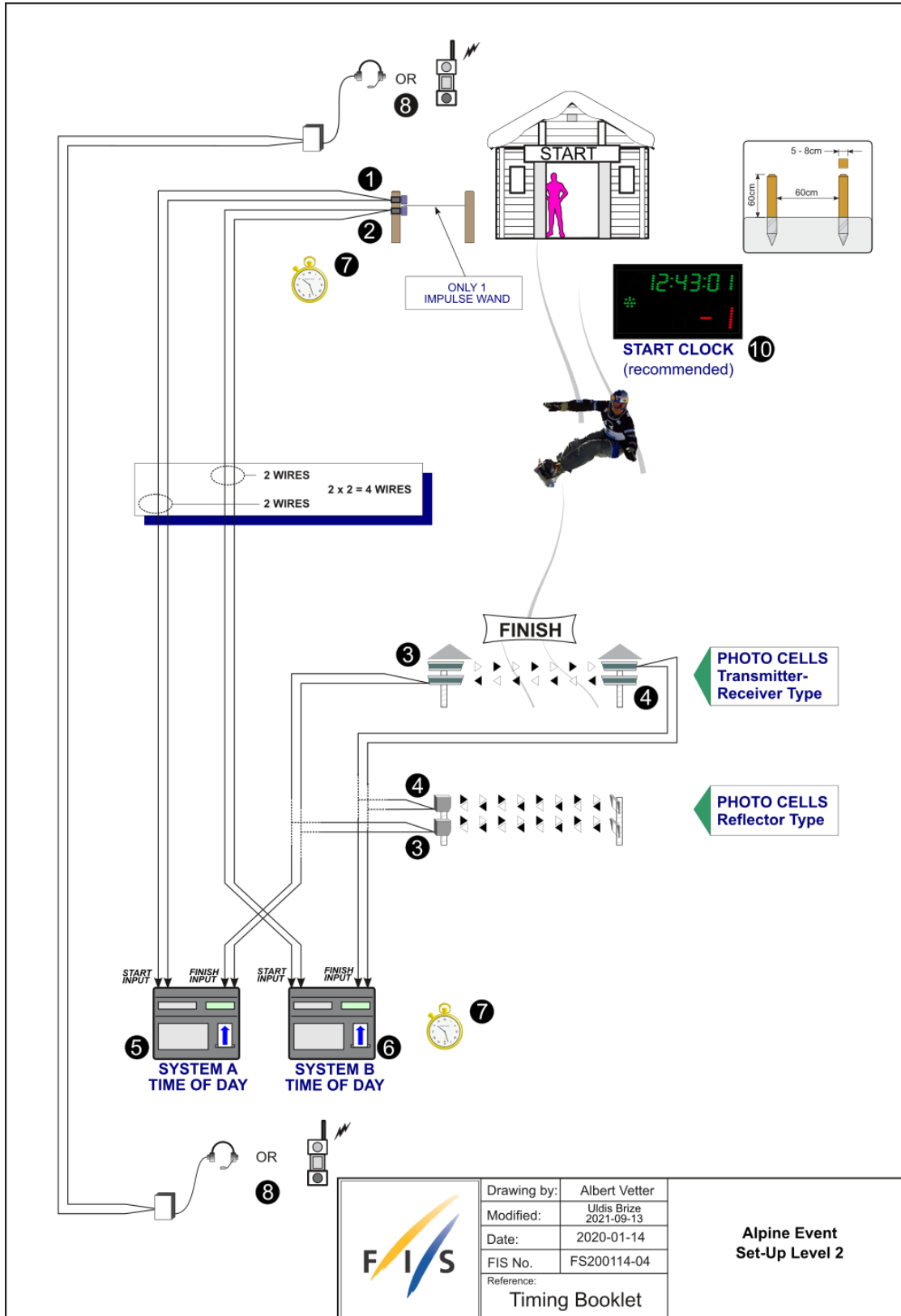

	Drawing by:	Albert Vetter
	Modified:	Uldis Brize 2021-09-13
	Date:	2020-01-14
	FIS No.	FS200114-04
	Reference:	Timing Booklet

**Alpine Event
Set-Up Level 2**

7.17. Alpine Event Set-Up Level 3 (One Cable)

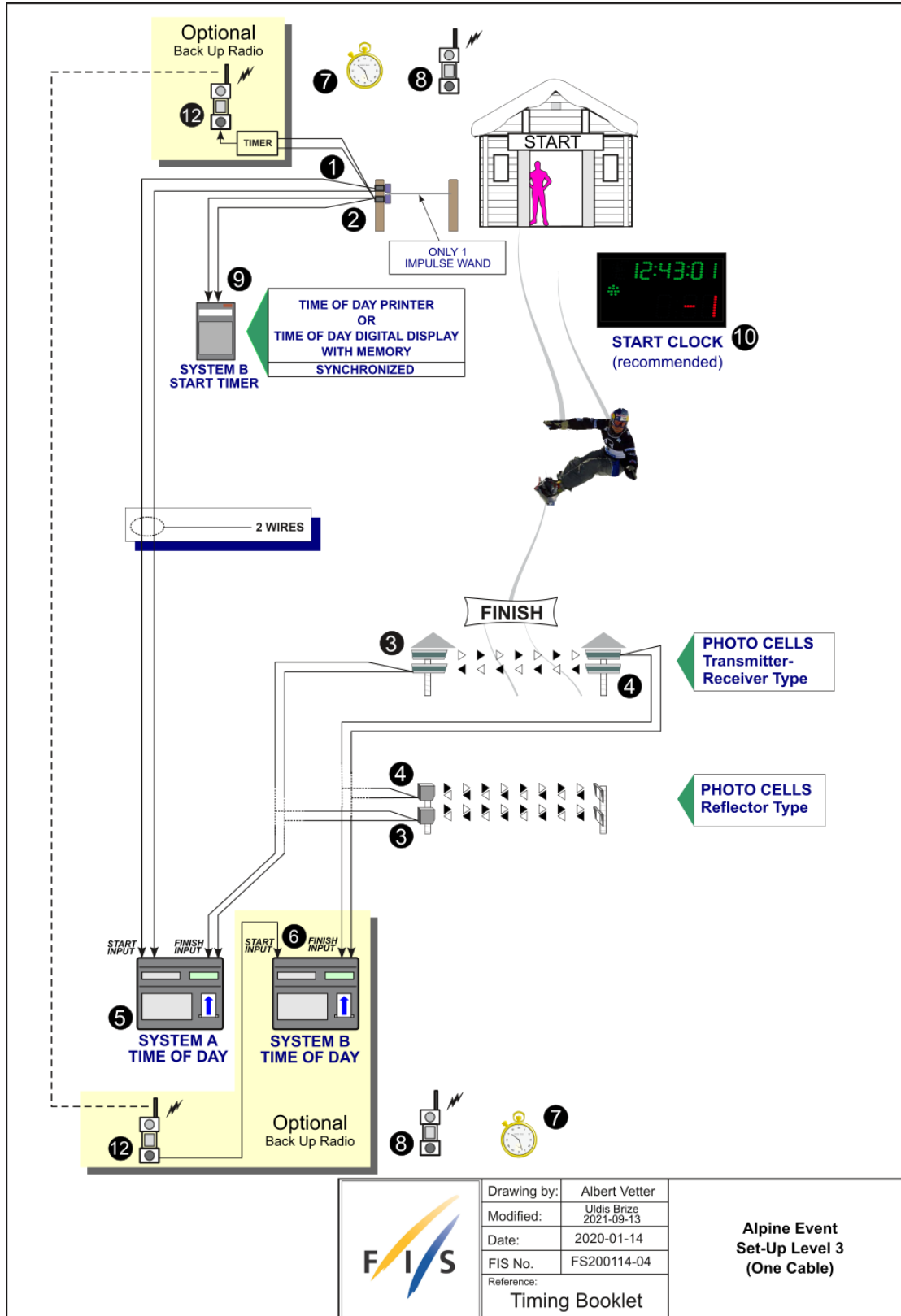

	Drawing by:	Albert Vetter
	Modified:	Uldis Brize 2021-09-13
	Date:	2020-01-14
	FIS No.	FS200114-04
	Reference:	Timing Booklet

**Alpine Event
Set-Up Level 3
(One Cable)**

7.18. Alpine Event Set-Up Level 4 (Without Cable)

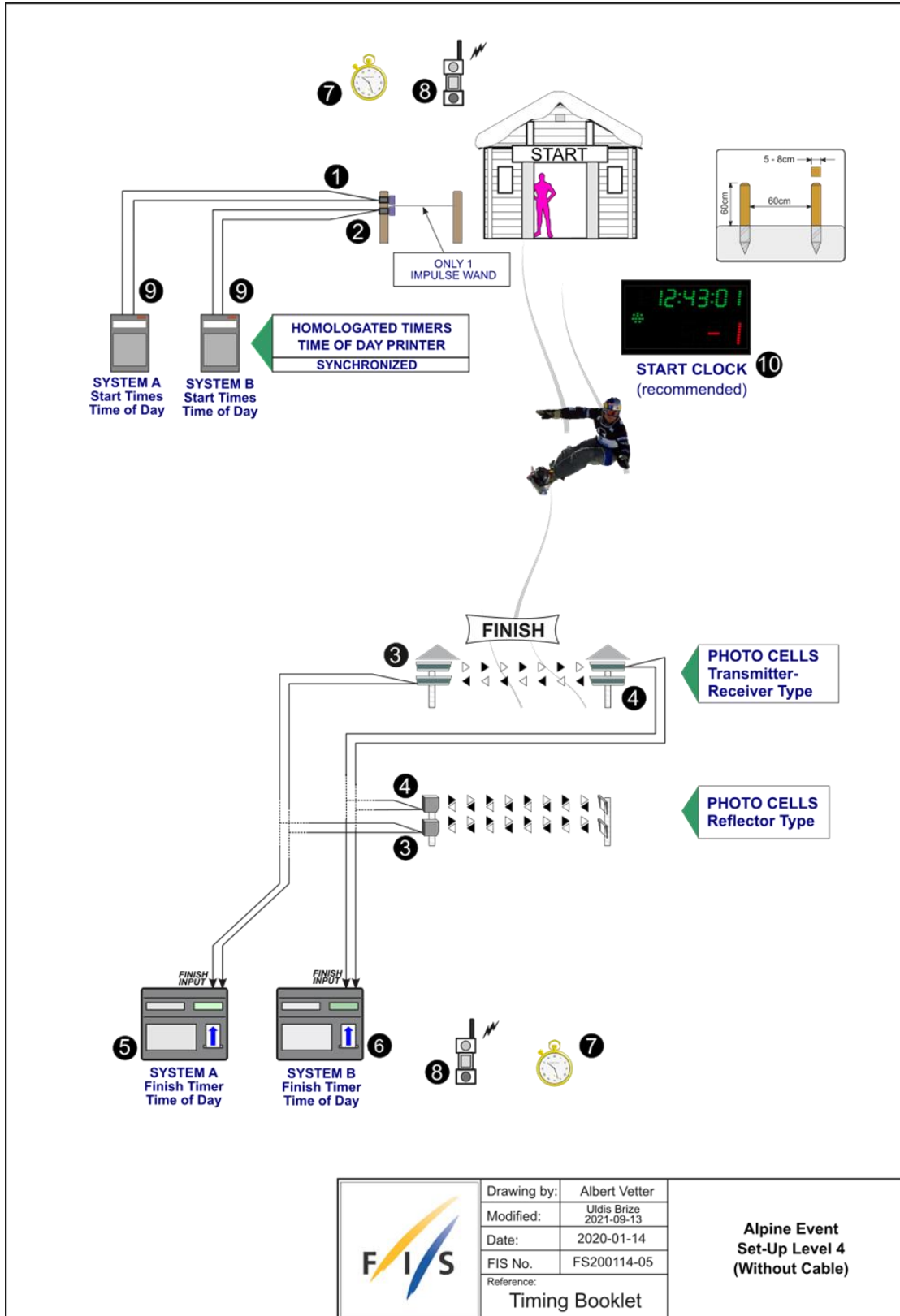

	Drawing by:	Albert Vetter
	Modified:	Uldis Brize 2021-09-13
	Date:	2020-01-14
	FIS No.	FS200114-05
	Reference:	Timing Booklet

**Alpine Event
Set-Up Level 4
(Without Cable)**

8. Important ICR rules for Freestyle and Snowboard timing

8.1. Overall

2015.1 Communications & Cabling

In all international competitions, there must be multiple communication (telephone or radios, etc.) between the start and finish. Voice communication between starter and finish must be assured by fixed wire connection or radio. In case of radio, this must be on a separate channel from that used by any other function. For judged competitions there must be direct communication between start, finish and the judges stand.

In Olympic Winter Games, FIS World Championships, World Cup and FIS Junior World Championships all communications and timing connections between start and finish must be assured by fixed wiring (except HP). In the data service area, access to the highspeed internet is required for World Cup, World Championships and Olympic Winter Games competitions.

2015.2 Timing Equipment and Timing Procedures (For SB Alpine, Cross and Moguls/Dual Moguls Competitions)

For all Snowboard Alpine Competitions, Cross Competitions and Moguls/Dual Moguls Competitions in the FIS Calendar, electronic timers, start devices and photocells homologated by FIS must be used. Specifications and procedures for timing are described in the FIS Timing Booklets and event related timing rules can be found in the Event Chapters.

8.2. Aerials

4107.2 Velocity Indicator

Velocity indicators must be provided at all Aerials sites. The display must be located on the Judges' Stand and must be readable from the table area and be expressed in kilometres per hour. The measurement must be taken at the transition between the inrun and the table according to the FIS Freestyle Course Standards 108 Manual. This installation is the responsibility of the Chief Time Keeper (see 4103.3).

4117.1.4 Start Permission and "Three Phase Start"

Start permission and starting time control at OWG, WSC and WC, competitions will be determined by means of a three-coloured (red-yellow-green) signal, tone and a digital display which are connected and run by an adjustable program.

During the red phase (start preparation), the clock does not run and is set at 20 seconds. During next yellow phase, (10 seconds) the clock starts, with a tone and runs down from 20 seconds and then switches after 10 seconds, with tone to the green phase. There will be a tone for each second for the last 5 seconds.

The starting time will be finished after 20 seconds and the display then shows '0'. At '0', the light automatically changes back to red and the starting procedure for the next competitor begins.

8.3. Moguls

4204.2.2 Moguls Start Area

The Moguls Start will preferably be an open start with a light beam installed approximately 1.5 - 2.0 metres down across the hill parallel to the starting line. The starting line and the light beam will be as wide as the control gates on top of the course are set. There will be a starting line. Competitors should plant their poles in front of the line and their boots should stay behind until the starting signal is given.

The starting installation will be located where competitors have easy access to their skiing line and can quickly reach full speed after leaving the start. Refer to Timing Booklet.

4204.6.2 Hand Timing

A hand timing system must be used at all times, as a back up to the electric timing system. Hand timing systems and their use shall comply with the provisions of the Freestyle Timing Booklet.

8.4. Dual Moguls

4304.2.4.4 Dual Moguls Gate Standards

Two hinged gates each 200-cm wide and 40 cm in height shall be attached to a horizontal pole. A start handle is attached at 90° to the horizontal pole in the centre of the two start gates. The starting block (behind the board) must be covered with plastic to protect the skis. The weight for each hinge gate is 15 kg.

4304.2.4.5 Opening System

The opening system shall operate in such a way that both gates open outwards on operation of a single control mechanism. Mechanical controls are preferred over electrical ones, for reasons of reliability and portability.

4304.6.2 Hand Timing

A hand timing system must be used at all times, as a back up to the electric timing system. Hand timing systems and their use shall comply with the provisions of the Freestyle Timing Booklet

8.5. Cross

5201.2.3 Timing without Cable

For Qualification, wireless timing, maybe used for FIS, NC and COC Level Competition. Timing devices must meet FIS wireless standards that are set out in the Timing Booklet

5201.2.7 Reaction Time

For World Cups, World Championships and Olympic Winter Games a reaction time will be measured. For the technical requirements refer to the timing booklet

5201.2.8 Intermediate Times

Intermediate Times are measured times on the track between Start and Finish line. They are just for information for the teams, competitors, media and officials and have no impact on the official results or official ranking.

As the times are not for official use, they can be measured with non-homologated timing devices.

For World Cups, World Championships and Olympic Winter Games intermediate times should be measured at least every 20-30 seconds. Intermediate Times are not required for Lower Level Events.

For the technical requirements refer to the Timing Booklet

5406 Determination of a Finish in Timed run's (Qualification)

With electric timing, the time is taken when competitors cross the line between the finishing posts with any part of their bodies or equipment and so breaks the contact.

5407.2.1 Ski Cross

Ranking in each heat is determined by the first part of the body that crosses the Finish line.

5407.2.2 Snowboard Cross

Ranking in each heat is determined by the first part of the body or the snowboard that crosses the Finish line.

8.6. Alpine Snowboard

6204.4 Timing without Cable

For Qualification, wireless timing, may be used for FIS, NC and COC Level Competition. Timing devices must meet FIS wireless standards that are set out in the Data & Timing Booklet

6204.5 Hand Timing

For timed qualifications hand timing at the start and finish is mandatory, for the technical details ref Data & Timing Booklet

6405 Crossing the Finish Line

The finish line must be crossed:

- with at least one foot attached to the board
- with both feet in case of a fall in the immediate finish area. In this case the time is taken when any part of the competitor's body or equipment stops the timekeeping system.

9. EET Calculation

The EET (Equivalent Electronic Time) you need in case a time from system A is missing. All times used for the final result must be from system A. If there is a failure of system A, a calculated net time (EET) from system B must be used following the same procedure as shown below. It is not permitted to substitute time-of-day times from system B for use with system A for the purpose of net time calculations. If the time is not available from system B use the photo finish time (if available), otherwise hand time.

Calculation of the correction

To calculate the correction time, use the 10 times of day of the competitors started before the one with the missing time. If there are not 10 times before, complete the calculation with the remaining times after the missed time. Subtract the A system times from the back up times for these 10 competitors. The sum of the 10 calculated time differences is divided by 10 and rounded up or down ($0.0444 = 0.044$, $0.0455 = 0.046$). This correction time must be added or subtracted to the replacement time of the competitor without a system A time.

The EET calculation must only use time of day precision to a minimum 1/1000th for the correction value of the time of day. If Hand timing is only available to precision of 1/100th, the full precision of 1/1000th or better must be used for the system A times.

Electronic A Finish Time in TOD: 10:48:31.9781

Hand Timing: 10:48:31.86(00)

Rounding for EET-Time Calculation (*):

$1.1575 / 10 = 0.11575 \Rightarrow 0.1158$ (rounding up for 5 or higher)

$1.1574 / 10 = 0.11574 \Rightarrow 0.1157$ (cutting below 5)

9.1. Example if System A and Backup Time has the precision of 1/1000th

BIB	Hand Time (only with 1/100 th)	Finish Time System A	Time Difference	Explanation
11	13:00:00.483	13:00:00.263	0.220	Time difference of Bib 11
12	13:00:26.521	13:00:26.880	-0.359	Time difference of Bib 12
13	13:00:47.410	13:00:47.368	0.042	Time difference of Bib 13
14	13:01:04.232	13:01:04.368	-0.136	Time difference of Bib 14
15	13:01:27.544	13:01:27.775	-0.231	Time difference of Bib 15
16	DNF	DNF	0.000	Racer did not finish
17	13:02:12.993	13:02:12.912	0.081	Time difference of Bib 17
18	13:02:42.501	13:02:42.616	-0.115	Time difference of Bib 18
19	13:03:00.211	13:03:00.944	-0.733	Time difference of Bib 19
20	13:03:20.694	13:03:20.280	0.414	Time difference of Bib 20
21	13:03:48.560	13:03:48.559	0.001	Time difference of Bib 21
22	13:04:12.158	missed time	-0.816	Sum of above time differences
Calculate Correction Time			-0.0816	$0.0816 = 0.816 / 10$
Correction Time after Rounding*			-0.082	
Calculate EET Time: Source Time - Correction Time				

22	$13:04:12.158 - (-0,082) = 13:04.12.240$
EET for Bib 22	13:04.12.240

9.2. Example if System A and Backup Time has the precision of 1/10,000th

Bib	Hand Time (only with 1/100 th)	Finish Time System A	Time Difference	Explanation
1	10:00:50.3548	10:00:50.1292	0.2256	Time difference of Bib 1
2	10:01:52.0189	10:01:52.1921	-0.1732	Time difference of Bib 2
3	10:02:49.4978	10:02:49.4920	0.0058	Time difference of Bib 3
4	10:03:50.6148	10:03:50.9812	-0.3664	Time difference of Bib 4
5	10:04:49.2741	10:04:49.8729	-0.5988	Time difference of Bib 5
6	10:05:50.4702	10:05:50.5129	-0.0427	Time difference of Bib 6
7	10:06:48.9125	10:06:48.8615	0.0510	Time difference of Bib 7
8	10:07:51.5814	missing time	0.0000	Missing time
9	10:08:49.8751	10:08:50.0002	-0.1251	Time difference of Bib 9
10	10:09:49.2459	10:09:49.4278	-0.1819	Time difference of Bib 10
11	10:10:50.3954	10:10:50.3473	0.0481	Time difference of Bib 11
8	10:07:51.5814	missing time	-1.1576	Sum of above time differences
Calculate Correction Time			-0.11576	$-0.11576 = 1.1576 / 10$
Correction Time after Rounding*			-0.1158	
Calculate EET Time: Source Time - Correction Time				
8	$10:07:51.5814 - (-0.1158) = 10:07:51.6972$			
EET for Bib 22	10:07:51.6972			

9.3. Example if Using a Hand Time with 1/100th

Bib	Hand Time (only with 1/100 th)	Finish Time System A	Time Difference	Explanation
1	10:00:50.35(00)	10:00:50.1292	0.2208	Time difference of Bib 1
2	10:01:52.01(00)	10:01:52.1921	-0.1821	Time difference of Bib 2
3	10:02:49.49(00)	10:02:49.4920	-0.0020	Time difference of Bib 3
4	10:03:50.61(00)	10:03:50.9812	-0.3712	Time difference of Bib 4
5	10:04:49.27(00)	10:04:49.8729	-0.6029	Time difference of Bib 5
6	10:05:50.47(00)	10:05:50.5129	-0.0429	Time difference of Bib 6
7	10:06:48.91(00)	10:06:48.8615	0.0485	Time difference of Bib 7
8	10:07:51.58(00)	missing time	0.0000	Missing time
9	10:08:49.87(00)	10:08:50.0002	-0.1302	Time difference of Bib 9
10	10:09:49.24(00)	10:09:49.4278	-0.1878	Time difference of Bib 10
11	10:10:50.39(00)	10:10:50.3473	0.0427	Time difference of Bib 11
8	10:07:51.58(00)	missing time	-1.2071	Sum of above time differences
Calculate Correction Time			-0.12071	$-0.12071 = 1.2071 / 10$
Correction Time after Rounding*			-0.1207	
Calculate EET Time: Source Time - Correction Time				
8	$10:07:51.58(00) - (-0.1207) = 10:07:51.7007$			
EET for Bib 22	10:07:51.7007			

10. Timing & Data Technical Report Form

The FIS provides free of charge a software program to fill out the “Timing & Data Technical Report”. You can download it from the FIS website Timing & Data subsection or the FIS FTP server: <ftp://ftp.fis-ski.com/Software/Programs/TimingReport>.

The software download is available for Windows and Mac OS and Linux.

With the electronic report the time keeper can send the report independently from the TD to the FIS. The timekeeper just goes through the form and fills in all the fields required for each discipline and sends it as XML file. Of course, the time keeper can still print the timing & data technical report to have a printed document.

The FIS only accepts the Timing & Data Technical Reports that are sent as XML file. Printed reports that are sent by mail, fax or e-mail will be not accepted.

The “Timing & Data Technical Report Form” must be completed and sent to FIS for the following events:

- Alpine Snowboard
- Ski and Snowboard Cross
- Moguls and Dual Moguls

A detailed documentation of the Timing Report software can be found on the FIS website Timing & Data section <https://www.fis-ski.com/en/inside-fis/document-library/timing-data> or within the Timing Report Software.

11. Criteria for FIS Approved Timing Devices FIS Competitions

All timing devices must be homologated by FIS and used respecting FIS rules. Validity of the homologation is for all timing devices except start doors 15 years. For start doors the validity is 10 years.

11.1. Timers

Timer	The timing device must have an internal printer or external printer (e.g. RS232, RS422, USB, Ethernet, WLAN, Bluetooth). Printing through a computer is not allowed. The timer must be able to operate in Time-of-Day. The output of the time must always have the same precision (e.g. printer, display and interface).
Printer	This printer must print at least in a chronological order the time of day. For each printed time of day there must be an indication of the timing channel. If it is possible to do manipulation or correction of times in the timer the printer must mark such a corrected time.
Interface	The timing device needs an interface (e.g. RS232, RS422, USB, Ethernet Ethernet, WLAN, Bluetooth) to connect a PC and transfer the data for data processing (result service) online. The communication protocol must be forwarded to the FIS for the homologation test.
Power Supply	The timing system must work with both, internal batteries and external power. The timing system must work without external power supply on internal batteries for 4 (four) hours at +10° C and two impulses per minute with printout. The timing system must work without power supply from the mains for four (4) hours at 23°C and one printout per minute and two (2) hours at -10°C and one printout per minute.
Operation Temperature	The timing device and printer must work at ambient temperatures from -10° to +60°C*
Measuring Range	Time of day mode must be possible in hours, minutes, seconds and 1/10000, or better.
Timer Precision	Must measure 1/10000 second or better in time of day mode. Timer accuracy must be below +/- 10 PPM at a device temperature from -10° to +60°C*.
Quartz	Ageing of the quartz must be below +/- 3 PPM per year. The time drift must be below +/-0.5 PPM at a constant temperature of 23°C.
Impulse Triggering	The delay of impulses is not allowed to be higher than 1/1000 sec. for the same channel (the channel is triggered from a reference impulse device in minute intervals). If two channels are triggered at the same time they times must be within 1/1000 second. The delay of impulses must be constant; the range must be less than 1/10000 sec.
Timing Channels	The timing device needs a minimum of two independent channels, one for start and one for finish.
Synchronisation	Synchronisation between main and backup timer must be possible.

Electromagnetic	The timing device must meet the standards of IEC (International Electronic Commission). This means the timing device must function satisfactorily in its electromagnetic environment without introducing intolerable electromagnetic disturbances to anything in that environment.
Truncation	<p>The truncation to 1/100 of seconds must be made after the calculation of the run time. The digits of the run time after the 1/100 are thrown away. E.g.:</p> <p style="text-align: center;">Start Time: 10:00:00.123</p> <p style="text-align: center;">Finish Time: 10:01:30.259</p> <p style="text-align: center;">Calculated Run Time: 1:30.127</p> <p style="text-align: center;">Run Time after truncation: 1:30.12</p>

Timers with External Synchronisation

For timing devices with external synchronisation (e.g., GPS-Synchronisation) all specifications of “Timers” (see previous page) are valid. Additionally it must fulfil the following features:

- The external synchronisation solution must have a constant accuracy from 0.0001 s or better.
- The timing device must run independent with the internal quartz.
- The time synchronisation of the external device can be in periodic intervals or permanent.
- If the difference between the internal timing (quartz) and the external synchronization is within an accuracy of +/-0.0003 seconds, it is allowed to resync the timing device with the external time.
- If the difference between the internal time (quartz) and the external time is higher than +/- 0.0003 seconds, it is not allowed to resync the timer with the external time. From now on the timing device must run with the internal quartz only (no further resynchronisations are allowed).
- The printer of the timer must print a message when the external synchronisation is switched off. The message must inform about the reason for switching the external synchronisation off and the time when this happens.
- In case the external synchronisation signal is lost the timer has to print a message. If the timer gets the synchronisation signal again further synchronisation is allowed if the time difference is within the allowed +/-0.0003 seconds.

11.2. Start Gate

Install the Start Gate in close co-ordination with the Technical Delegate and/or the Competition Jury. Only Start Gates homologated by FIS are allowed (see section of homologated timing equipment in this booklet and on FIS website).

The following elementary rules should be considered:

- Start Gate mounting post must be put into the ground or snow or firmly connected to a fixed structure under the snow. It is essential that the support post be solidly fixed and not permitted to move in any way.

- The Start Gate must likewise be attached to the mounting post without the possibility of rotation or movement of any kind.
- The height above the ground of the Start Gate must permit the athletes to hit the bar below the knee not too close to the boot top. In all cases the range shall not be less than 35cm nor more than 50 cm above the snow surface at the start.
- The start gate may be placed either to the left or the right of the starting competitor, in all cases making sure that the angle of departure to the first gate ensures that the start gate must open.

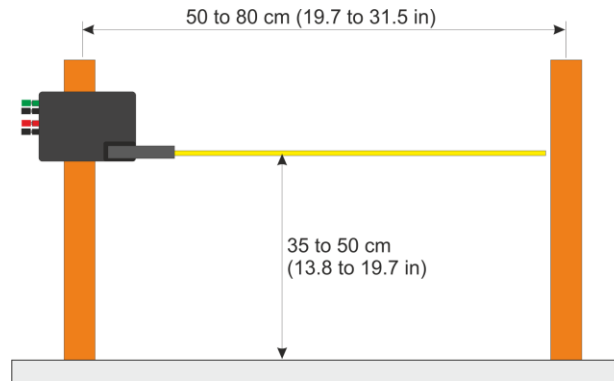

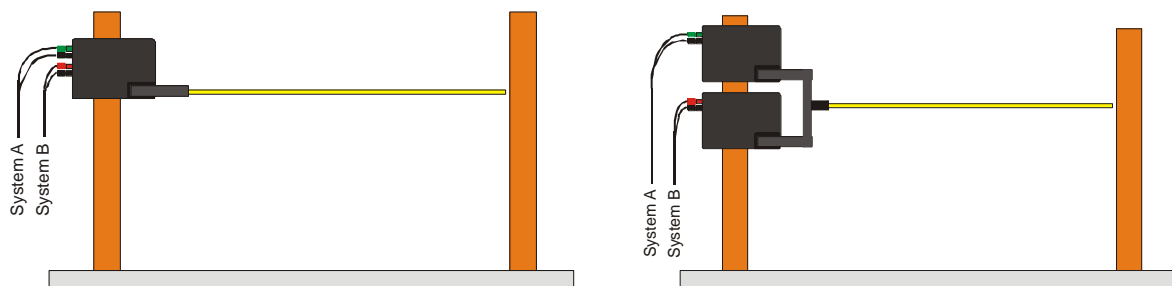

- The length of the wand (bar) must be within 50 cm (20 in) and 80 cm (31,5 in)
- The Start Gate must have two different and completely isolated lines, two separate connectors, one for timing system A and one for timing system B



- If two Start Gates are used in parallel, they must be solidly mounted on the same physical bracket and each arm must be stiffly connected together (both mechanism and box)
- Only the use of one wand (bar) is permitted
- If the Start Gate has to be replaced during the competition, it must be a Start Gate of the same type and manufacturer
- The position of the Start Gate (both height and rotation) must be marked before the beginning of the competition in order to make sure that a replacement can be installed in the same position if necessary

Technical Specifications for Start Gates

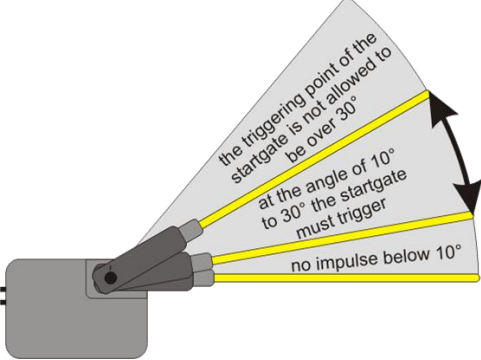
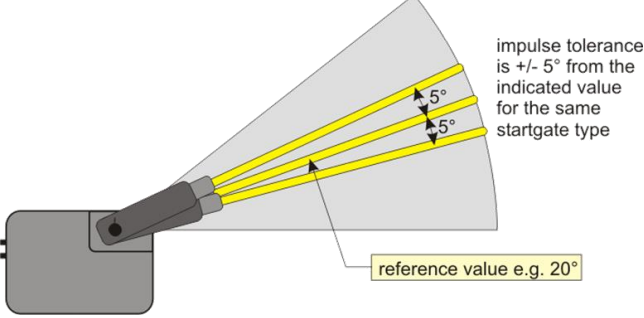
Only Start Gates that meet the following technical specifications will be homologated by FIS.

<p>Contacts</p>	<p>The Start Gate shall provide a separate contact for system A and B. Each contact needs a separate, but identical switch. Both contacts must be completely electrically separated.</p>
<p>Angular Range</p>	<p>Both impulses must be given at an angular range of the start wand between 10° and 30°, calculated from the closed position (when the wand is stiff). Starting gates that do not meet this trigger angle are not admitted.</p> 
<p>Angular Accuracy</p>	<p>Both impulses shall be given by starting gate switches of the same type with an angular accuracy of +/- 5° respect to the indicated rotation of the start wand.</p> 
<p>Start Wand</p>	<p>The start wand cannot be so stiff that it could cause injury and that it will not break. On the other hand it must be as stiff as possible to avoid unfair starts. If you rotate the start wand at the far end, it is not allowed to bend more than 15° without causing the triggering mechanism to actuate. The wand must stay open once it is activated. Spring return “Self-Returning” mechanisms are not permitted. For Cross-Country an automatic rewinding start gate is allowed.</p> 
<p>Start Gate Impulses</p>	<p>Two different possibilities are accepted:</p> <ol style="list-style-type: none"> 1. Single Shot: the line is activated for predetermined time even if the wand remains open 2. Continuous: the line remains activated as long as the wand remains open.

11.3. Start Clock

A Start clock is a device that helps the Starter to organize the start. A Start clock is highly recommended for Cross Qualification and Aerials and is mandatory for use at Level 1. It must work in time-of-day mode.

Display	The start clock has a visible start display to the athletes. The display can be analogue or digital. <ul style="list-style-type: none"> • Analogue Clock: The clock must be visible over a distance of at least 10m • Digital Clock: The figures must be visible over a distance of at least 10m • Time of day: hours, minutes and seconds (min. 6 digit) • Countdown: minutes and seconds (min. 3 digit) • Bib: to show the bib is not mandatory, but can be an option
Start Indicator Light	The start clock must show if the start is free (green indicator) or not allowed (red indicator).
Acoustic Countdown	The start clock needs an acoustic countdown. The acoustic countdown has at least one beep at each second during the last five seconds (low tone from five seconds to 1 second and high tone at zero).
Countdown	The start clock needs at least three start interval countdown times. During the race it must be possible to change from one start interval to another. The duration of each start interval must be adjustable at any time (before the race or during the race).
Interface	The start clock needs an interface (e.g., RS232, RS422, USB, Ethernet) to transfer the data.
Power Supply	The start clock must work without power supply from the mains for eight (8) hours at 23°C. The start clock must work without external power supply on internal batteries for 6 (six) hours at -20° C.
Operation Temperature	The start clock must work at ambient temperatures from -20° to +60°C*
Measuring Range	Time of day mode must be possible.
Timer Precision	Must measure 1/100 second or better in time-of-day mode. Timer accuracy must be below +/- 10 PPM at a device temperature from -10° to +60°C.
Quartz	Ageing of the quartz must be below +/- 3 PPM per year. With adjusted quartz frequency the time drift must be below +/-0.5 PPM at 23°C.
Synchronisation	Synchronisation with other timing devices must be possible.
Electromagnetic	The timing device must meet the standards of IEC (International Electronic Commission). This means the timing device must function satisfactorily in its electromagnetic environment without introducing intolerable electromagnetic disturbances to anything in that environment.

11.4. Start Door

The start door homologated by the FIS is needed for the following events: parallel events, team events, Snowboard Cross, Ski Cross.

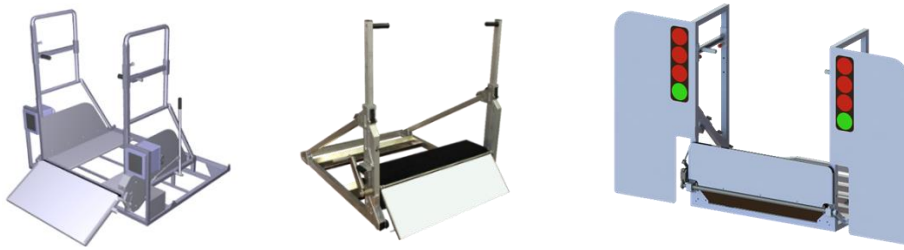

- Dimension of the hinged flap panel, outside the snow must be more than 95 cm wide, 25 to 40 cm height
- The side that has contact with the skis must be protected using material that protects the skis.
- Competitors must not be able to push the gates open. A force applied at any position on the hinged flap panel at 25 cm above the snow with 150 N is not allowed to open or block the start door.
- A handle is on each side of the start door. It is used for the competitors to start. The handle is mounted on the inside. The handle must be adjustable in the height between 60 and 100 cm (measured from the snow level).
- One push button must start the automatic start sequence for all involved start doors.
- The start door or start-electronic must provide an output channel to start the timing.
- The start door must be able to be opened with a delay (e.g. for one racer at the second run at parallel races). For level 1 events it is mandatory.
- The start door must have an a potential free impulse output to connect a timing device (one output contact for each gate).
- Starting lights visible for the athletes may be available for parallel competitions and team events. Red light(s) shows the countdown and a green light the start (door opens). The lights show the countdown from 3 seconds to zero. For level 1 it is mandatory. For cross events the starting lights must be able to be switched off.
- Starting sound for the athletes may be available for parallel competition and team event. It is counting down synchron with the light from 3 seconds to zero. The sound and light must start exact with the full second. For level 1 and 2 it is mandatory. For cross events the starting sound must be able to be switched off or changed to one start tone.
- Sound and light must be synchronized. Same sound for the red lights and different sound for green light.
- For Cross-Events the hinged start panels must be connected for all gates by one bar. This means all gates must open at the same time.
- The manufacturer of the start door must provide a checklist to maintenance the start door. Before each FIS race that uses the start door the start door has to be checked by the checklist and a copy of the checklist has to be provided to the TD at least 2 weeks before the race.
- Validity of the homologation is 10 years, it can be homologated for parallel, cross or both.

Start Door measurements:

Description	Specifications
Distance between handles [A]	80 - 90 cm
Handle or knob height over snow [B]	adjustable, 60 - 100 cm
Vertical handle movement [C]	max. 10 cm step
Handle diameter [D]	3 - 5 cm
Width of hinged flap panel [F]	min. 95 cm
Hight of hinged flap panel over the snow [G]	25 - 40 cm
Distance between start doors for Cross events [H]	60 - 70 cm
Closing angle of hinged flap panel	0 - 15°
Opening angle of hinged flap panel	min. 140°
Time to open hinged flap panel to 90°	max. 0.3 s
Variation of opening duration of hinged flap panel	max. 0.1 s
Time to open hinged flap panel from start impulse to 90°	max. 0.4 s
Force applied on hinged flap panel to 25 cm over snow level without opening	min. 15 kg
Operating temperature	-30°C to +60°C
Surface of hinged start panel (side that skier moves over)	protection for skis

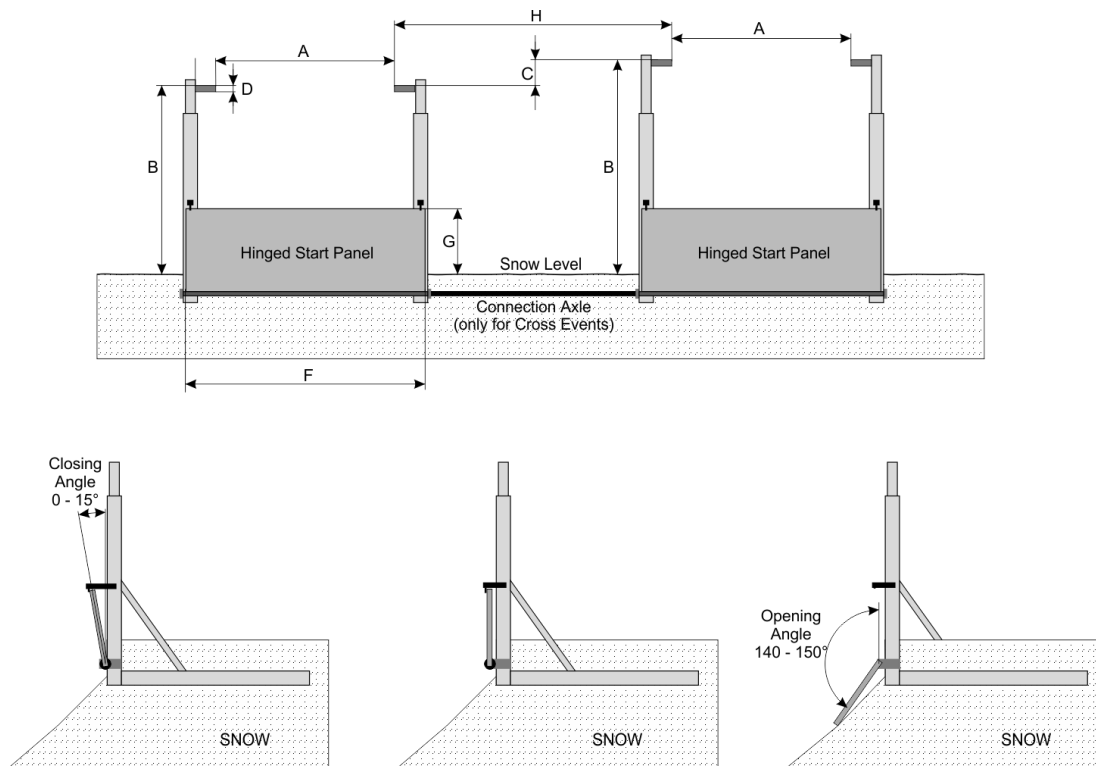

Installation for parallel races and team events has to follow the plan below:

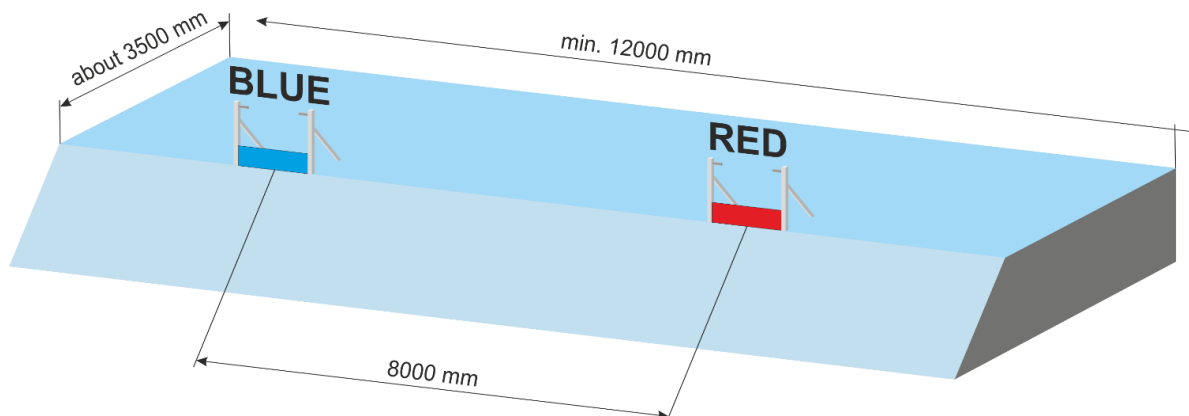

11.5. Photo Cell

Install photo cells in close co-ordination with the Technical Delegate and/or the Competition Jury. It is strongly recommended that the approach to the finish and the width of the line be made as levelled as possible, making it impossible for athletes to slide under or jump over the beams when installed.

Only wooden posts with a maximum diameter of 6 cm should be used to mount the photo cells at the finish. You should cut the wood posts so they can break away in case of being struck by a competitor. This cut must be made facing uphill. All brackets and elements of the photo cells should be placed on the downhill side of the post. If photo cells for intermediate times are used they should be mounted on hinged poles that will break away.

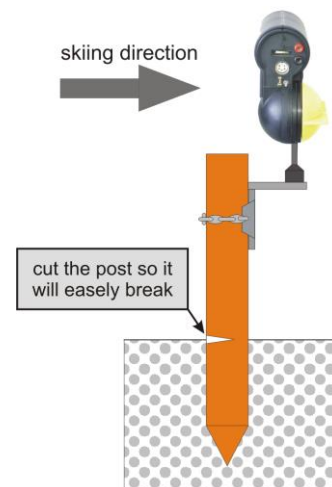

Photo cell system A and B must always be completely separate (separate case and mounting brackets).

For photo cells appropriate protection must be provided by the organizer.

Only photo cells homologated by FIS are allowed to be used for the finish (see section on homologated timing equipment in this booklet or on FIS website).

There are two categories of cells:

1. Reflector Type:

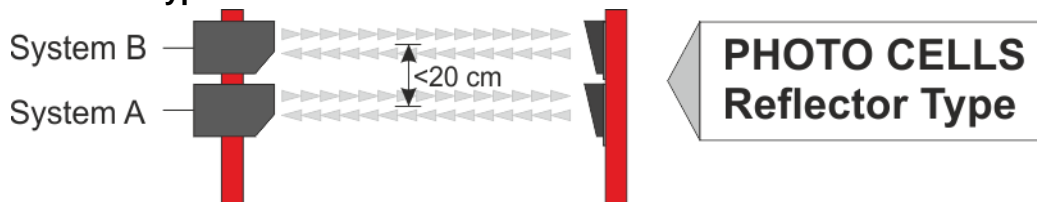

The reflector-type photo cell has the transmitter and receiver electronics in the same case. A simple reflector on the opposite side of the finish line is used to reflect the photo cell beam back to the main unit. For System A and B the reflectors should be on the same side.

2. Transmitter-Receiver Types:

In this case the transmitter is on one side of the finish, and the receiver is on the other side. For System A and B transmitters can either be on opposite sides or on the same side.

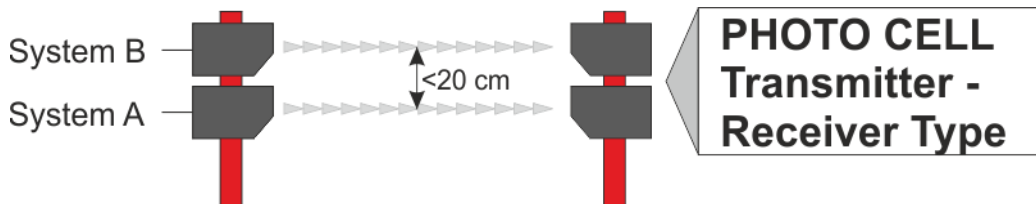
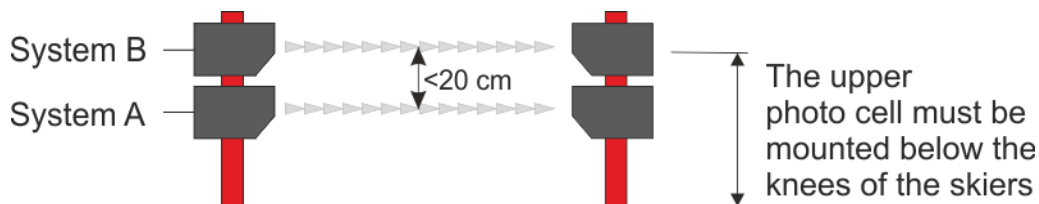

Photo Cells for the Finish:

It is necessary to have two independent sets of photo cells for the finish, one connected to Timing System A and one for Timing System B. The cells must be mounted so that both beams are triggered at a height that is lower than the knee of competitors at the finish. It is recommended that the lowermost photo cell be connected to Timing System A.

The photo cells must be set up parallel to the finish on top of each other. Either the same post or two separate posts for both photo cells can be used. The maximum vertical separation of the beams may not exceed 20 cm (8"), and in all cases should be less than that if possible.



For the Transmitter-Receiver Type the transmitters of the photo cell can be either on the same side or opposite side (see manufacturer specifications). The beams may be installed in a crossed configuration but in all cases the 20cm maximum vertical separation must be observed.

Photo Cells at the Start:

For the qualification of Cross and Moguls competitions photo cells are used at the start. For level 2 or higher a direct wire connection to the finish is not necessary, but in this case each photo cell that has no direct wire connection to the finish needs a separate timing device connected to the photo cell at the start.

Photo Cells at the Finish:

The photo cells must be connected to the timing devices by fixed cable. No radio transmission of photo cell signals to the timers is allowed for the finish photo cells.

Photo cells for Intermediate Time:

There is no requirement to have a backup (System B) photo cell for the intermediate time.

If you use photo cells install them in close co-ordination with the Technical Delegate and/or the Competition Jury.

To avoid the photo cells (if used) being triggered by anyone other than the competitors, it is recommended that the person responsible for that intermediate timing point use a push-button to arm the photo cells only when a competitor crosses the line.

Technical Specifications for the Photo Cell

The technical concept of the photo cell is not restricted by FIS, although it must be assured that the photo cell cannot be influenced by any other light, camera flash/strobes, radio waves (EMI) or mobile reflectors for photo cells of reflector type.

The photo cell must meet the standards for electronic devices in the country that it is sold.

Accuracy	Sensing Time - The time delay from the instant the photo cell is triggered to moment an output impulse is generated may not exceed 0.005 sec. Repeatability (Random Jitter) - The delay of impulses must be constant, the range must be less than 5/10.000 sec. This range is measured in a "peak-to-peak" manner, minimum to maximum extremes, it is not averaged.
Operating Distance	The photo cell must work over a minimal distance of 20 m. The maximum size of the reflector (if used) is 100mm (in all directions).
Triggering Object	An 8 mm object moving with a speed of 10 km/h is not allowed to trigger the photo cell (measured at a distance of 2 m from lens of the receiver). A 100 mm object moving with a speed of 200 km/h must trigger the photo cell (measured at a distance of 2 m from lens of the receiver). The object must be a black cylinder.
Temperature Range	-20 to +60°C (for colder weather you should prepare a cover so the photo cell will still work).
Power Supply	If the photo cell is supplied power from the timing device (within the same cable as the impulses) it needs no external power supply. If a battery is used as the power supply (external or internal) the photo cell must work for four (4) hours at -20°C.
Reflector	max. size is 10 cm (diagonal)
For homologation of photo cells	When sending photo cells for homologation, the photo cell needs an input contact to switch the photo cell transmitter off, in order to make precise tests

11.6. Photo Finish Systems

A photo finish system can be used to determine a competitor's finish time.

In the case of a failure of System A and System B, and where the competitors finish has been recorded by the photo finish system, this finish time must be used in the place of hand timing. The finish time of the photo finish must be used without any corrections.

The photo finish time is taken when any part of the competitor's body crosses the finish line. The photo finish result is only to be provided to the jury.

For night races using a photo finish a light with min. 2000 Lux is necessary. If possible, the light should be without bright and dark phases. LED light is recommended.

The angle of the photo finish camera must have a minimum of 20° to the middle of the finish line.

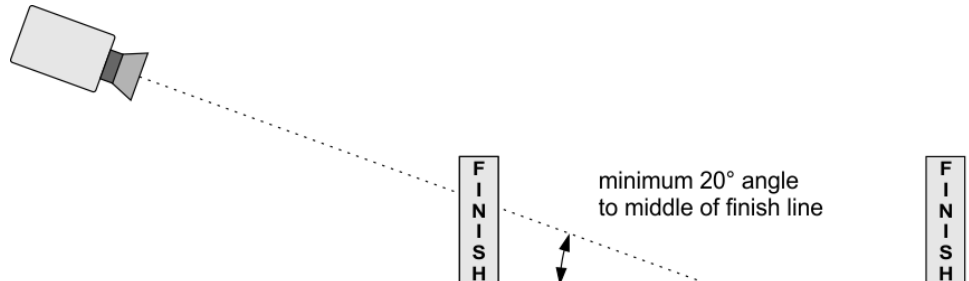

All photo finish systems must meet the following criteria for use in FIS competitions:

Timer	The timer must be able to operate in Time-of-Day mode and be synchronized with all timing devices.
Operation Temperature	The photo finish camera must operate (once it is started) at ambient temperatures from -10° to +60°C.
Measuring Range	Time of day mode must be possible in hours, minutes, seconds and 1/1000, or better.
Timer Precision	Must measure up to 1/10000 second or better in time-of-day mode. Timer accuracy must be below +/- 10 PPM) at a device temperature from -10° to +60°C.
Quartz	Ageing of the quartz must be below +/- 3 PPM per year. With adjusted quartz frequency the time drift must be below +/-0.5 PPM at 23°C.
Impulse Triggering	The delay of impulses is not allowed to be higher than 1/1000 sec. for the same channel (the channel is triggered from a reference impulse device in minute intervals). The delay of impulses must be constant; the range must be less than 1/10000 sec.
Timing Channels	The timing device needs a minimum of one timing channel for time-of-day synchronisation.
Synchronisation	It must be possible to synchronize the timing device with other timing devices.
Image Production	The photo finish system must scan the finish line at a minimum of 2000 scans per second and show images sequentially and show scanned finish line images in sequential order on a monitor screen and store it on a memory device.
Image Evaluation	The photo finish system must be capable of showing the time of day for each line scan image.
Power Supply	Backup power supply must be granted for a minimum of 20 minutes (e.g., internal battery or external UPS).
Electromagnetic	The timing device must meet the standards of IEC (International Electronic Commission). This means the timing device must function satisfactorily in its electromagnetic environment without introducing intolerable electromagnetic disturbances to anything in that environment.

12. Homologation of Timing Equipment

Manufacturers wishing to have their timing devices, start gate, photo cells or photo finish system homologated for use in FIS competitions must send a request to the Timing Working Group through FIS office which will instruct the manufacturer to provide all technical information indicated above. Software for photo finish systems are not part of the homologation. The costs of homologation have to be paid by the manufacturer.

If a manufacturer homologates prototypes FIS will not consider it for homologation. Only final versions of a device (as it is sold in public) will be homologated by FIS.

Attention

All temperatures for the specification of timing equipment are given with a tolerance of +/-1°C.

List of Homologated Timing Equipment

The List of homologated timing equipment is not included in the timing booklet any more. Please check this list on FIS webpage - <https://www.fis-ski.com/en/inside-fis/document-library/timing-data>

13. Conclusion

We hereby wish to thank all members of the "FIS Timing Working Group" who have always used every endeavor to realize this "FIS GUIDE" for their Technical Delegates and event organizers. Our progress since 1996 reflects the balance between accepting new technologies and ensuring the correct evaluation of human performance through fundamental timekeeping concepts.

We wish to acknowledge the major contributions of participating manufacturers, FIS professionals and volunteers from our many members National Associations and competition organizers who give so much of their time and expertise without which it would be impossible to generate such a document or perspective.

FIS is pleased to support such a unique group in the world of timekeeping regulation and notices the absence of similar structures in many other high-performance sports that rely so heavily on timing technology for fair and impartial judgement.

We are fully aware that there are still some imperfections in these rules and descriptions and would welcome any constructive proposal as the works proceed. This document will be continually revised to improve the knowledge of FIS community for the benefit of all Freestyle Skiing competitions.

Please contact us with your suggestions and comments:

Member	E-mail
Daniel Defago (FIS – Chairman)	defago@fisski.com
Ulf Seehase (FIS)	seehase@fisski.com
Uldis Brize (FIS)	brize@fisski.com
Raphaël Blanchard (SUI)	Raphael.Blanchard@swisstiming.com
Ted Savage (CAN)	tsavage@precisiontiming.com
Albert Vetter (AUT)	albert@alge-timing.com
Frederico Gori (ITA)	fgori@microgate.it
Tommy Jauhojärvi (FIN)	tommy@emit.no

14. Change Log

14.1. Version 1.3, 26.09.2023

Section	Description
Start clock homologation	<ul style="list-style-type: none"> Remove the sentence mentioning that start clock homologation will be required starting from 2022 season.
Set up drawings	<ul style="list-style-type: none"> Level 1 - 2 Parallel events – mention that hand timing at finish is optional when photo finish camera is used. Level 1 - 2 Cross events and all levels of Team Cross – always require two photo finish cameras for OWG and WSC of which one camera is pointing towards the finish line from the other side of the course.

14.2. Version 1.2, 13.09.2022

Section	Description
Global	<ul style="list-style-type: none"> Update document template
Timing without cable connection	<ul style="list-style-type: none"> Rewrite the Timing Without Cable chapter with the updated wording (see 6).

14.3. Version 1.06, 13.09.2021

Section	Description
Global	<ul style="list-style-type: none"> Update document template Move change log to the end of the file Updated titles and paragraphs to be inclusive of both Snowboard and Freestyle.
Competition Levels	<ul style="list-style-type: none"> Move category YOG to Level 1 Move category AC to Level 1 Move category NC to Level 3 Delete category UNI Remove the discipline column Add sentence below the table to describe in more detail how technical setup should be selected for Level.
Equipment	<ul style="list-style-type: none"> Add sentence that requires timing devices to use maximum possible precision under System A and System B timer descriptions Update the “Voice Communication” description to say - “must be on separate” instead of “can be on separate”.
Procedures	<ul style="list-style-type: none"> Replace the old “Dual Moguls” time difference chapter with a more general “Parallel Competition difference calculation” to be inclusive of both Snowboard and Freestyle. Update “Timing Report” to require report for both Snowboard and Freestyle Cross, and add Alpine Snowboard
Timing without cable connection	<ul style="list-style-type: none"> Add links to examples of setup “without cable” illustration

between Start and Finish	<ul style="list-style-type: none"> Update 1st paragraph to reference only competition Levels, not specific competition categories, as those are already within the allowed Levels.
Set-Up Examples	<ul style="list-style-type: none"> Updates to illustration titles to avoid “higher” and “lower”. Cross Qualification Set-Up for Level 1 - update illustration to allow also homologated start doors or start gate. Moguls and Cross Qualification Set-Up Level 2 - update illustration to allow also homologated start doors or start gate. Moguls and Cross Qualification Set-Up Level 4 (One Cable) - update illustration to allow also homologated start doors or start gate. Moguls and Cross Qualification Set-Up Level 4 (Without Cable) - update illustration to allow also homologated start doors or start gate. Dual Moguls Set-Up Level 1 - Remove hand timing icon at Start Dual Moguls Set-Up Level 2 to Level 4 - Remove hand timing icon at Start Cross Set-Up Level 3 and Level 4 – Update to require high refresh rate camera also for Level 4 Cross Set-Up Level 4 or Higher – Remove Team Cross Set-Up Level 1 + 2 – Remove Team Cross Set-Up Level 3 + 4 – Remove Team Cross Set-Up for all Levels – New illustration requiring Photo Finish and Start Doors with delayed opening feature. Parallel Set-Up Level 1 to Level 2 – Add hand timing for both finishes Parallel Set-Up Level 3 – Separate into two different illustrations showing setup for “difference in finish” and “run time”. Hand timing at start required only when “run time” is calculated. Alpine Event Set-Up – Start clock marked as “recommended” for all levels
Important ICR rules for Freestyle and Snowboard timing	<ul style="list-style-type: none"> Whole chapter updated with extracts from the latest ICR version.
Timing & Data Technical Report Form	<ul style="list-style-type: none"> Update to require report for both Snowboard and Freestyle Cross, and add Alpine Snowboard
Criteria for FIS Approved Timing Devices FIS Competitions	<ul style="list-style-type: none"> Specify that photo finish times must be used without correction.
Conclusion	<ul style="list-style-type: none"> Update Timing Working Group member list

14.4. Version 1.05, 01.09.2021

Section	Description
Page 5	Start Clock
Page 16	Change of Sketch for Dual Moguls Set-Up Level 1
Page 17	Change of Sketch for Dual Moguls Set-Up Level 2 or Higher
Page 19	Change of Sketch for Cross Set-Up to Level 3 (not 3 and 4)

Page 21	Sketch for Team Cross Level 1 + 2
Page 22	Sketch for Team Cross Level 3 + 4
Page 24	Sketch for Parallel Level 1 or higher), manual hand timing
Page 25	Sketch Parallel Level 2: manual hand timing
Page 34	Timers: some precision in the text
Page 38	Start Clock: Homologation needed for season 2021/2022
Page 39	Multiple changes: <ul style="list-style-type: none"> • Start Door: start light and start sound duration is now 3 seconds. • Homologation for parallel, cross or both.

14.5. Version 1.04

Section	Description
Page 9	Photo Finish is not necessary for Dual Moguls, change of text
Page 11-12	Moguls and Cross Qualification Set Up for Level1 is now a separate sketch
Page 14-15	Changed form Level 2 to Level 4
Page 16	Photo Finish for Freestyle Dual Moguls not necessary in sketch
Page 18	Ski Cross Set-Up Level 1 and 2 (new sketch)
Page 19	Ski Cross Set-Up Level 3 (new sketch)
Page 23-24	EET Calculation
Page 25	Timing & Data Technical Report Form
Page 26	Timers: some technical data were changed
Page 29	Start Gate: automatic rewinding for Cross-Country allowed
Page 30	Start Clock
Page 31-32	Start Door: specifications and technical data were changed
Page 35	Photo Finish System: timer precision was expressed more precise

14.6. Version 1.03

Section	Description
Page 4	New Table for Level Classification
Page 7	Multiple updates: <ul style="list-style-type: none"> • Photo finish System • Synchronisation
Page 9	Parallel Competitions – For level 0 a photo finish is mandatory. In case of a missing A and B time the time of the day of the photo finish can replace the A-time.
Page 11-20	All Sketches for Set-Up are updated
Page 21	ICR 3041 - Technical Installation

Page 22	EET Calculation
Page 24-29	Timing and Technical Report Form
Page 30	Timers: <ul style="list-style-type: none"> • Precision 1/10,000th or better • Additional example for truncation of time calculation
Page 31	Timers with External Synchronisation
Page 34	Start door – several changes
Page 38	Photo finish – 2000 Lux for night races

14.7. Version 1.02

Section	Description
Page 4	New Table for Level Classification
Page 1 – 38	Adaptation of levels in the complete text.
Page 11 - 19	New sketches (level changed)
Page 21	New Rules of ICR 3041 - Technical Installation
Page 22	EET calculation
Page 24	Photo finish camera
Page 32	Multiple updates: <ul style="list-style-type: none"> • Start doors • Opening when pressure against start door • Mechanical connection of start panels at Cross competitions • Checklist for maintenance
Page 33+34	Start doors - new sketches